



INTERGLASS

USA's Largest Glass and Hardware Distributor



ESTABLISHED SINCE 2004

— Reaching over 35 states —

OUR PURPOSE

To offer dependable, timely and diverse solutions that glass fabricators need FOR SUCCESS.

Since our establishment in 2004, Interglass has been dedicated to the wholesale distribution of glass and mirror products. We have a combined footprint of 144,000 sqft of warehouse space and a specialized fleet of trucks which includes: Boom Trucks, Rack Trucks and Tractor-trailers. We efficiently perform in-house all of our local logistics needs such as: customs clearance, drayage, warehousing and deliveries. This, combined with our extraordinary employees, give us the ability to exceed our customer needs and offer a reliable service.

WHY CHOOSE US AS YOUR TRUSTED DISTRIBUTOR?



Our extensive product portfolio lets you combine various glass, mirror, and hardware items in one order

Flexible One-Stop Shop



Our own fleet of trucks ensures quick and timely deliveries

Just-in-Time Deliveries



We keep over 6,000 cases of glass and mirrors in stock for availability and variety

Large Inventory



Our specialized trucks with cranes can unload orders directly into your warehouse

Effortless Unloading



INDEX

- Distribution Regions / Types of Services 4**
- Our Timeline..... 5**
- Our Branches..... 6**
- Float Glass 8**
 - Clear Glass 9
 - Low Iron Glass..... 10
 - Hard Coat Low-E Glass 11
 - Tinted Glass..... 12
 - Patterned Glass 13
 - Satin Acid-Etched Glass 14
 - Black & White Painted Glass 15
- Laminated Glass..... 16**
 - Clear Laminated Glass 17
 - Tinted Laminated Glass 18
 - White Interlayer Laminated Glass 19
- Mirrors 20**
 - Clear Mirror 21
 - Low-Iron Mirror 22
 - Tinted Mirror 23
 - Antique Mirror 24
 - Satin Mirror 25
 - One-Way Mirror/Diamond Polished Wire Glass.... 26
- Glazing Tools..... 27**
 - Glass Fabrication Tools 28
 - Glass & Mirror Installation tools 29
- Swinging Shower Doors 32**
 - Standard Size Shower Doors 33
 - Wall Mount Hinges 34
 - Glass to Glass Hinges 36
 - Pivot Hinges..... 38
 - Handles & Towel Bars 40
 - Fixed Panel Clamps 41
 - Glass to Glass Clamps..... 42
 - No Hole Clamps 44
 - U-Channels..... 45
 - Header & Parts 46
 - Seals..... 47
- Sliding Shower Doors 48**
 - Century Sliding System 49
 - Denali Series 50
 - Clearwater Series..... 52
 - NAPA series 54
- Glass Railings 56**
 - Base Shoe Railing 59
 - Standoff Railings 60
 - Handrails 61
- Office Partition..... 62**
 - Commercial Pivot Door Parts 63
 - Commercial Fixed Panel Parts..... 65
- Exports 66**
- Our Core Values..... 67**

AVAILABLE FINISHES

Brass

Chrome Polished	CP
Brushed Nickel	BN
Matte Black	MB
Brushed Gold	BG

Aluminum

Brite Anodized	BA
Brushed Anodized	BS
Matte Black	MB
Dark Bronze	DB
Satin Anodized	SA
Satin Brass	SB

Stainless Steel

Polished Stainless.....	PS
Brushed Stainless.....	BS
Matte Black	MB
Satin Brass.....	SB

DISTRIBUTION REGIONS

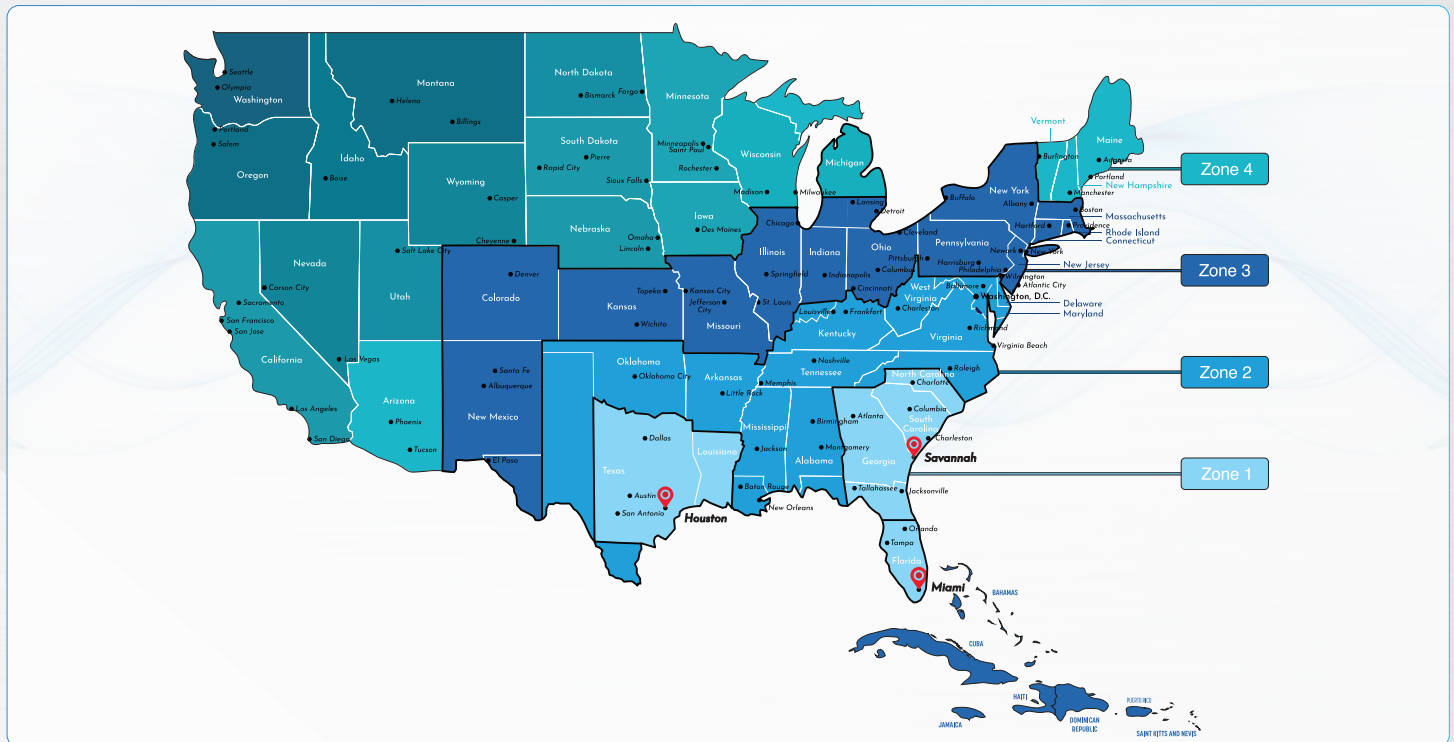

TYPES OF DELIVERY

Boom Truck Delivery Service



- Offered in Zone 1 only
- Unloading of Glass & Mirror cases included in service
- Single lite delivery only for TX and FL

Tractor-Trailer Delivery Service



- Single drop trailer for easier unloading
- Rolling tarp to protect from rain during transit
- Combine Glass or Mirror cases from our stock
- Competitive price vs float plants
- Cases or stoce packs

Direct Container Delivery Service

- Directly from the manufacturer to customers warehouse
- Lowest cost service
- Drayage and Customs costs included in FL and TX
- Offered in South Florida and central Texas and some Caribbean islands only
- Close or open top available



OUR TIMELINE

2004

- Established in March 2004 at 8440 NW 66th Street, Miami, FL



Miami, FL

2007

- Moved to 2175 W 8th Ct. Hialeah, FL with 10,000 sqft



Hialeah, FL

2008

- Acquired the first Boom Truck and hire first CDL driver



2011

- Moved to 6550 NW 82 Ave, Miami, FL with 26,000 sqft
- Exhibited at GlassBuild Show in Atlanta for the first time
- Introduced shower door hardware product line



Miami, FL

2015

- Acquired assets of Vetro USA in Medley, FL
- Acquired the first tractor trailer
- Closed branch in Tampa, FL



2019

- Moved to 8150 NW 64 St, Miami, FL with 55,000 sqft
- Opened a branch in Savannah, GA with 30,000 sqft
- Earned the rank of #4433 on the Inc. 5000 list
- Exhibited at GlassBuild Show in Atlanta



Miami, FL



Savannah, GA



2021

- Exhibited at GlassBuild Show in Atlanta, GA
- Introduced SAMSARA GPS Tracking System
- Started in-house drayage from Port Miami and Port Everglades

2024

- Celebrating 20 years
- Exhibited at Glass Expo South East in Orlando, FL
- Exhibited at MGA Glass Expo in Washington, D.C.
- Exhibited at Expo North East in New York, NY
- Exhibited at GlassBuild America in Dallas, TX
- Opened a branch in Houston, TX with 62,000 sqft

2025

- Exhibitors at the Glasstexpo trade show in San Antonio, TX
- Exhibitors at the GlassBuild trade show in Orlando, FL
- Sponsors for the Glasstexpo and GlassBuild 2025 trade shows

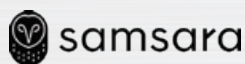

Houston, TX





OUR BRANCHES

We're thrilled to unveil our **NEWEST** branch.

HOUSTON









MIAMI, FL

-  8150 NW 64th Street Miami, FL 33166
-  53,000 sqft
-  Showroom
-  Splitting of Large Lites available
-  Hardware & Single Lites pick-up available
-  Pick-up Hours: 8:00am to 6:00pm
-  Office Hours: 8:00am to 4:30pm

& SERVICES



HOUSTON, TX

-  10355 Deer Trail Dr. Houston, TX 77038
-  62,000 sqft
-  Showroom
-  Splitting of Large Lites available
-  Hardware & Single Lites pick-up available
-  Pick-up Hours: 8:00am to 4:30pm
-  Office Hours: 8:00am to 4:30pm



SAVANNAH, GA

-  2367A Tremont Rd #100 Savannah, GA 31405
-  30,000 sqft
-  Pick-up Hours: 7:00am to 6:00pm
-  Office Hours: 8:00am to 4:30pm

FLOAT GLASS

Meets Standards:

ASTM C1172-14
EN14449
ANSI Z97.1

Visible Light Transmittance (VLT): The percentage of the visible spectrum (light) that is transmitted through the glass.

Exterior Reflectance: The percentage of the visible spectrum (light) that is reflected towards the exterior by the glass.

SHGC: The fraction of incident solar radiation admitted through the glass, both directly transmitted and absorbed and subsequently released inward. SHGC is expressed as a number between 0 and 1. The lower a glass solar heat gain coefficient; the less solar heat it transmits.

Winter U- Value: Measure of the insulating characteristics of the glass in which how much heat gain or loss occurs through the glass due to the difference of indoor and outdoor temperatures using NFRC winter nighttime environmental conditions of a cold outside temperatures and no sunlight.

Interglass cannot be held responsible for any deviation between the data introduced and the conditions on site. Specifications technical and other data are based on information available at the time of preparation of this document and are subject to change without notice. Data values were simulated using Optics 6 & used with Windows 5.2. The performance data is simulated, not actually measured.



Clear Glass

Clear glass is a soda-lime silicate float glass product, intended to be used in residential and commercial applications alike. It's a versatile choice when specialty glass is not needed. It has the standard light green color. It's the type of glass used the most worldwide and the least expensive, and can be used in almost any glass application. Such as double glazing, laminating, tempering, heat-strengthening, bending, coating.

Clear Glass is used on many applications such as: Windows, Doors, etc. As it's an affordable and available product, it's one of the most common and popular choices in the glass industry. Clear glass is commonly used in the industry due to its slight green hue that alters the appearance in some cases, this is due to the iron content present in the glass.

Glass Thickness		Visible Light		UV Transmittance	Solar Heat Gain Coefficient (SHGC)	Winter U-Value English	Winter U-Value Metric W/(M ² x K)	Thickness Tolerances	Dimension Tolerances
mm	inches	Transmittance (VLT)	Exterior Reflectance						
2.3mm	3/32"	90.0%	9.0%	N/A	0.87	1.05	5.94	±0.2mm	±4mm
3mm	1/8"	89.0%	8.6%	73.3%	0.85	1.04	5.90	±0.2mm	±4mm
4mm	5/32"	89.5%	8.6%	71.1%	0.84	1.04	5.88	±0.2mm	±4mm
5mm	3/16"	89.1%	8.5%	68.7%	0.83	1.03	5.86	±0.2mm	±4mm
6mm	1/4"	88.6%	8.5%	66.0%	0.82	1.02	5.82	±0.2mm	±4mm
10mm	3/8"	87.5%	8.3%	57.9%	0.76	1.00	5.69	±0.3mm	±4mm
12mm	1/2"	85.0%	8.0%	N/A	0.73	0.98	5.59	±0.3mm	±4mm
19mm	3/4"	83.0%	8.0%	N/A	0.67	0.95	5.39	±1.0mm	±5mm

Physical and Mechanical Properties	Symbol	Value and unit	Chemical Composition
Density (at 18°C)	ρ	2 500kg/m ³	Silicon Dioxide (69% to 74%)
Knop hardness	Hk0.1/20	6 GPa	Calcium Oxide (5% to 14%)
Young's modulus	E	7x10 ¹⁰ Pa	Sodium Oxide (10% to 16%)
Poisson's ratio	μ	0.2	Magnesium Oxide (0% to 6%)
Specific heat capacity	Cp	0,72 x 10 ³ J/(kg.k)	Aluminum Oxide (0% to 3%)
Nominal value of avg coefficient of linear expansion between 20 ° C and 300° C	α	9 x 10 ⁻⁶ /K	Other (0% to 5%)
Resistance against temperature differential and sudden temperature change	v40 Kb		
Thermal conductivity	λ	1 W / (m. K)	
Mean refractive index to visible radiation (at 589,3nm)	n	1,5	
Emissivity (corrected)	ε	0,837	
Characteristic bending strength	Fg,kk	45 N/ mm ²	

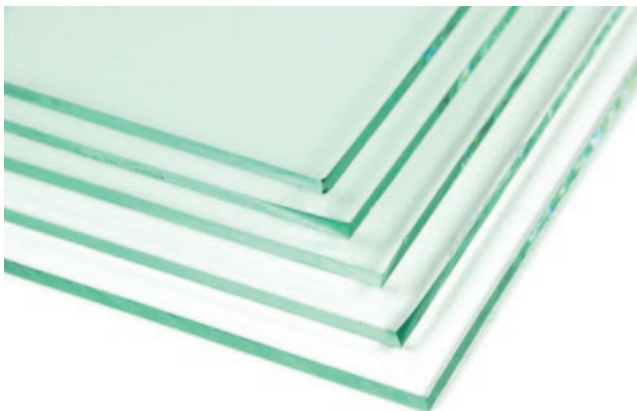

LOW IRON GLASS



Low Iron Glass

Low Iron Glass is an ultra transparent glass with light transmittance more than 91%. It has the characteristics of low spontaneous breakages, high purity, noble elegance and crowned as 'crystal prince' of the glass family.

High transmittance: visible light transmittance near 92%, 6% higher than clear float glass.

High aesthetics: More beautiful than clear float glass, with a jewellike blue edge.

Glass Thickness		Visible Light		Total Penetration	UV Penetration	Shading Coefficient	Winter U-Value Metric W/(M ² x K)
mm	inches	Transmittance (VLT)	Exterior Reflectance				
5mm	3/16"	91.3%	8%	90%	71%	1.03	5.80
6mm	1/4"	91.1%	8%	90%	70%	1.03	5.70
10mm	3/8"	90.6%	8%	89%	66%	1.02	5.60
12mm	1/2"	90.4%	8%	88%	64%	1.01	5.50
19mm	3/4"	89.7%	8%	86%	59%	0.99	5.50

Edge Guide

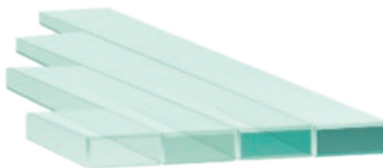

The color of a glass edge depends on the length of glass you are looking through.

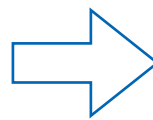

Low-Iron Glass	Regular Clear Glass
Length 12"	Lightest Blue
Length 20"	Light Blue
Length 40"	Medium Blue
Length 60"	Dark Blue
Length 100"	Very Dark Blue
Length 130"	Black



Benefits of Low-Iron Glass:

1. Elegance
2. Luxury Finish
3. High Quality
4. Undistorted Colors
5. Clarity





Hard Coat Low-E Glass (Energy Select)

Energy Select® is a line of low-emissivity coated glass products engineered to surpass the most rigorous code requirements for commercial applications. These high-performance glass solutions not only meet current standards but also equip architects to tackle future design challenges. Offering a wide array of architectural low-e and tinted glass options, Energy Select® combines aesthetic appeal with energy efficiency to fulfill the specific design and performance needs of each project. Selecting the appropriate product is simplified: For Every Code. For Every Region.

Glass Thickness		Visible Light		UV Transmittance	Solar Heat Gain Coefficient (SHGC)	Solar Heat Gain Coefficient (SHGC)	Shading Coefficient (SC)
mm	inches	Transmittance (VLT)	Exterior Reflectance				
3.2mm	1/8"	83%	9.0%	38.9%	0.75	0.75	0.86
5mm	3/16"	82%	6.3%	30%	0.67	1.03	5.86
6mm	1/4"	53%	6.0%	25%	0.63	1.02	5.82



What makes it unique?

Pyrolytic passive solar low-e glass

- Provides thermal insulation with passive solar gain.
- High level visible light transmission 74% (VLT) for plenty of natural daylighting

Improved thermal performance

- Coating can be used on #4 surface, combined with a coating on the #2 surface for improved U-values for use in colder climates
- Can be used in retrofit window systems #4 surface to improve energy efficiency of older buildings

Unique aesthetic

- Coating on clear substrate for a more neutral appearance
- Low level indoor reflectivity
- Low-e coating technology
- Pyrolytic (hard) coating, with same shelf life as standard float glass
- Can be used monolithically, or as part of an insulating glass unit
- Worry-free transportation, handling, storage and processing
- Edge deletion not required





Bronze Glass

Bronze Tinted Glass offers solar protection and supports energy efficiency in regions that rely on air conditioning. Provides low levels of light reflection. Can be tempered, laminated, heat-strengthened, insulated. Ideal for use in atriums, skylights, windows, entrances and storefronts. Also in decorative applications such as table tops. This glass is a great option and alternative from traditional clear glass. It allows users to have different possibilities of architectural and decorative applications while at the same keeping the elegance the glass has to offer.

Glass Thickness		Visible Light		UV Transmittance	Solar Heat Gain Coefficient (SHGC)	Winter U-Value English Btu/(Hr x Sqft x °F)	Winter U-Value Metric W/(M ² x K)
mm	inches	Transmittance (VLT)	Exterior Reflectance				
3mm	1/8"	66.8%	6.8%	38.9%	0.73	1.04	5.90
5mm	3/16"	58.5%	6.3%	30.2%	0.67	1.03	5.86
6mm	1/4"	53.2%	6.0%	25.5%	0.63	1.02	5.82
10mm	3/8"	37.7%	5.4%	14.1%	0.52	1.00	5.69
12mm	1/2"	27.0%	5.0%	N/A	0.47	0.98	5.59



Gray Glass

Gray Tinted Glass has a subtle cool light-gray tint which offers traditional solar control. Tinted products support energy efficiency in regions that rely on air conditioning and low levels of light reflection. Can be tempered, laminated, heat-strengthened. Ideal for use in atriums, skylights, windows, entrances and storefronts. Gray Glass will provide a contemporary look while at the same time offering benefits that makes it a popular choice in architectural and display applications alike.

Glass Thickness		Visible Light		UV Transmittance	Solar Heat Gain Coefficient (SHGC)	Winter U-Value English Btu/(Hr x Sqft x °F)	Winter U-Value Metric W/(M ² x K)
mm	inches	Transmittance (VLT)	Exterior Reflectance				
3mm	1/8"	60.3%	6.4%	37.4%	0.68	1.04	5.90
5mm	3/16"	50.4%	5.9%	28.8%	0.62	1.03	5.86
6mm	1/4"	44.5%	5.6%	24.2%	0.58	1.02	5.82
10mm	3/8"	27.7%	5.0%	13.2%	0.47	1.00	5.69
12mm	1/2"	18.0%	5.0%	N/A	0.42	0.98	5.59



Green Glass

Green Glass offers some solar control. Tinted products supports energy efficiency in regions that rely on air conditioning and low levels of light reflection. Ideal for use in atriums, skylights, windows, entrances and storefronts. Green Glass can provide a fresh, vibrant look to architectural designs while at the same time providing an excellent option to products that contain light-sensitive contents due to it's moderate protection of UV radiation.

Glass Thickness		Visible Light		UV Transmittance	Solar Heat Gain Coefficient (SHGC)	Winter U-Value English Btu/(Hr x Sqft x °F)	Winter U-Value Metric W/(M ² x K)
mm	inches	Transmittance (VLT)	Exterior Reflectance				
3mm	1/8"	66.8%	6.8%	38.9%	0.73	1.04	5.90
5mm	3/16"	58.5%	6.3%	30.2%	0.67	1.03	5.86
6mm	1/4"	53.2%	6.0%	25.5%	0.63	1.02	5.82



Pattern 62 Obscured Glass

This pattern combines an attractive appearance with obscurity and light transmission capabilities, perfect for a range of residential and commercial applications. Mostly used in jalousie windows and kitchen cabinet doors. Also known as Nashiji, Dew or Crepe.



Rain Patterned Glass

Rain patterned glass option bring natural beauty indoors, offering obscurity, light diffusion and ripped pattern reminiscent of a summer shower. Mostly used in shower enclosures. Also known as Niagara.



Reeded Glass

Reeded glass is a type of textured glass featuring a series of parallel lines, or "reeds," which create a distinctive, decorative pattern. It's mostly used in doors, windows, cabinets, partitions and shower enclosures. Also known as Moru.



Aquatex

Aquatex glass is a type of patterned glass that was often used for privacy in various settings, such as bathroom windows, enclosures and patio tables. It can be tempered for safety to be used in areas like shower enclosures or exterior windows where safety glass is required by building codes. Also known as Aqualite.

Glass Thickness		Visible Light		Thickness Tolerance (mm)	Solar Transmission (%)	Solar Reflectance (%)	Winter U-Value Metric W/(M ² x K)
mm	inches	Transmittance (VLT)	Exterior Reflectance				
3.2mm	1/8"	89%	8.0%	(+/-) 0.3	85	8.3	5.80
5mm	3/16"	88%	8.0%	(+/-) 0.4	85	8.0	5.80
6mm	1/4"	87%	8.0%	(+/-) 0.5	83	8.0	5.80
10mm	3/8"	82%	8.0%	(+/-) 0.8	79	8.0	5.80

SATIN ACID-ETCHED GLASS



Satin Acid-Etched Clear Glass

Acid-Etched Glass, with a smooth satin finish appearance, creates a distinctive look that responds to current design trends toward minimalist and simplicity. Combines a satin finish with a smooth, translucent appearance. It filters light, smooths visual contours, and provides obscurity and privacy. Has a slight green tint. Commonly used in shower enclosures, obscurity windows, table tops, office partitions, closets, cabinets, picture frames, etc.

Satin Acid-Etched Low-Iron Glass

Low-Iron Acid-Etched glass, is a specialty glass that combines properties to give unique looks and performance. For instance, it has a frosted appearance with high clarity. It's common applications include doors, shower enclosures, tabletops and places where privacy is needed while at the same time allowing it to have natural light. Its neutral tone eliminates color changes.



Base Glass: Clear Float Glass or Ultra-Clear Low-Iron Float Glass

Application: Cutting, Polishing, Beveling, Bending, Tempering, Lamination

Glass Thickness		Makeup / Composition	VLT%	SHGC	Winter U-Factor
mm	inches				
3,2 mm	1/8"	1/8" Clear Glass (Acid Etched on One Side)	80	0,88	5,90
6 mm	1/4"	1/4" Clear Glass (Acid Etched on One Side)	81,5	0,86	5,83
10 mm	3/8"	3/8" Clear Glass (Acid Etched on One Side)	79,3	0,83	5,70
12 mm	1/2"	1/2" Clear Glass (Acid Etched on One Side)	78,5	0,82	5,63

Characteristic	AVCP	NPD
Safety in the case of fire:		
Resistance to fire (13501-2)	1	NPD
Reaction to fire (13501-1)	3,4	A1
External fire behavior (EN 13501-5)	3,4	A1
Safety in use:		
Bullet resistance (EN 1063)	1	NPD
Explosion resistance (EN 13541)	3	NPD
Burglar resistance (EN 356)	4	40K
Pendulum body impact resistance (EN 12600)	4	40K
Resistance against sudden temperature changes		
Temperature differentials	unit 4	10mm
Wind, snow, permanent and imposed load resistance of the glass. Protection against noise:	4	32 (-2;-3)dB
Direct airborne sound reduction (EN12758)		
Light transmission (EN 410):	3	80.1%



Black Back Painted Glass

Black Painted Glass is an ideal solution for commercial and residential spaces, mostly used in interior decor to show a piano black glossy look. Not temperable. Apply Safety back Cat II tape recommended. Available only in 6mm.



White Back Painted Glass

Low-Iron White Painted Glass is an ideal solution for commercial and residential spaces, mostly used in back-splashes and closet doors. Not temperable. Apply safety back Cat II recommended. Available only in 6mm.

Back Painted Glass is a lacquered glass with an opaque and colored appearance, attained by depositing and banking highly resistant lacquer onto the rear surface of the glass. This glass brings color and ambiance to interiors and is particularly suitable for more demanding locations such as bathrooms and kitchens.

Some of its common applications include: homes, offices, hotels, shops and museums. This is by creating smooth, homogenous surfaces as all-panelling, in furniture and in wardrobe and cupboard doors.

Some of the advantages of using this glass include: Inspiring modern-day design, durable and flawless finish, resistant to humidity and safety as well as an elegant and serene installation to the places it's placed at.



LAMINATED GLASS

Meets Standards:

ASTM C1172-14	Complies with category II rating under the 16 CFR 1201 Regulation.
EN14449	
ISO 12543	
ANSI Z97.1	

Visible Light Transmittance (VLT): The percentage of the visible spectrum (light) that is transmitted through the glass.

SHGC: The fraction of incident solar radiation admitted through the glass, both directly transmitted and absorbed and subsequently released inward. SHGC is expressed as a number between 0 and 1. The lower a glass solar heat gain coefficient; the less solar heat it transmits.

Winter U- Value: Measure of the insulating characteristics of the glass in which how much heat gain or loss occurs through the glass due to the difference of indoor and outdoor temperatures using NFRC winter nighttime environmental conditions of a cold outside temperatures and no sunlight.

Hurricane Impact Resistant Glazings: To meet the requirements of the ASTM E 1996 Small Missile Test, laminated glasses typically include a PVB interlayer with a thickness of 0.06" (1.52 mm) and for the Large Missile Test an interlayer of 0.090" (2.28mm) is required.

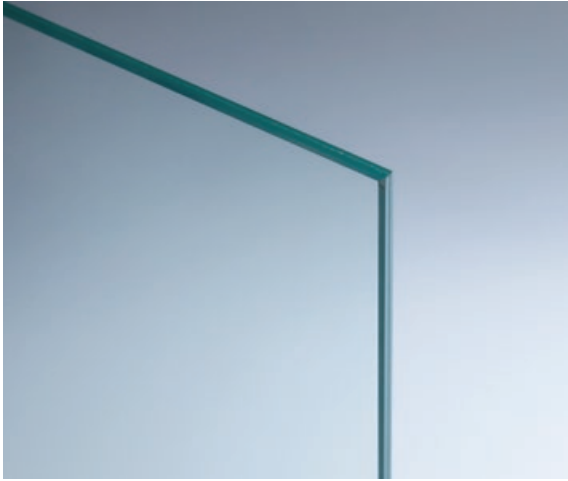

Clear Laminated Glass

Laminated glass is two or more lites (pieces) of glass permanently bonded together with one or more plastic interlayers (PVB: polyvinyl butyral) using heat and pressure. Laminated glass can be broken, but the fragments will tend to adhere to the plastic layer and remain largely intact, reducing the risk of injury.

Applications: Windows, Storefronts, Jewelry Showcases, Railings.

Glass Thickness		Makeup / Composition	VLT%	SHGC	Winter U-Factor
mm	inches				
6.76mm	1/4"	1/8" Clear Glass + 0.030" Clear PVB + 1/8" Clear Glass	88	0.79	1.00
8.28mm	5/16"	1/8" Clear Glass + 0.090" Clear PVB + 1/8" Clear Glass	88	0.76	0.96
10.76mm	3/8"	3/16" Clear Glass + 0.030" Clear PVB + 3/16" Clear Glass	87	0.76	0.97
12.28mm	7/16"	3/16" Clear Glass + 0.090" Clear PVB + 3/16" Clear Glass	87	0.72	0.94
12.76mm	1/2"	1/4" Clear Glass + 0.030" Clear PVB + 1/4" Clear Glass	87	0.75	0.96

Some features that Laminated Glass has is that it:

1. Provides Safety measures as when glass breaks it adheres to the plastic interlayer rather than breaking into pieces like common annealed glass.
2. Sound Insulation is also one of the characteristics as the PVB interlayer present in the laminated glass can absorb sound waves and reduce sound.
3. Laminated glass is used due to it's tough breakage.
4. Used in areas where Hurricanes, Tornados and Earthquakes are common as it can stand heavy wind loads and impact.

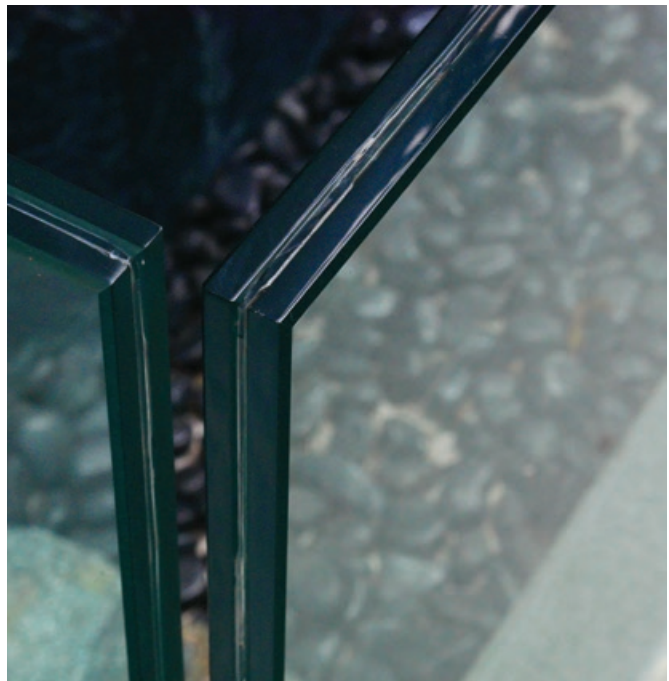



Bronze Laminated Glass

Bronze Laminated Glass has a bronze tint that provides an attractive appearance to buildings and structures. By having the interlayer, Laminated Glass offers safety in case of breakage. This is due to the interlayer holding the glass fragments together preventing them from scattering and causing harm. Also, laminated glass can help in the reduction of solar heat gain in the buildings interior.

Glass Thickness		Makeup / Composition	VLT%	SHGC	Winter U-Factor
mm	inches				
6.76mm	1/4"	1/8" Bronze Glass + 0.030" Clear PVB + 1/8" Bronze Glass	51	0.59	1.00
8.28mm	5/16"	1/8" Bronze Glass + 0.090" Clear PVB + 1/8" Clear Glass	50	0.58	0.96
12.28mm	7/16"	3/16" Bronze Glass + 0.090" Clear PVB + 3/16" Clear Glass	57	0.59	0.94



Gray Laminated Glass

Gray Laminated Glass has a gray tint that gives a modern and stylish appearance to buildings and structures. This tint also provides a touch of elegance and sophistication to the architectural needs. Also, it is utilized in interior designs for decorative elements and furniture.

Glass Thickness		Makeup / Composition	VLT%	SHGC	Winter U-Factor
mm	inches				
6.76mm	1/4"	1/8" Gray Glass + 0.030" Clear PVB+ 1/8" Gray Glass	42	0.55	1.00
8.28mm	5/16"	1/8" Gray Glass + 0.090" Clear PVB+ 1/8" Clear Glass	41	0.55	0.96
12.28mm	7/16"	3/16" Gray Glass + 0.090" Clear PVB +3/16" Clear Glass	49	0.55	0.94



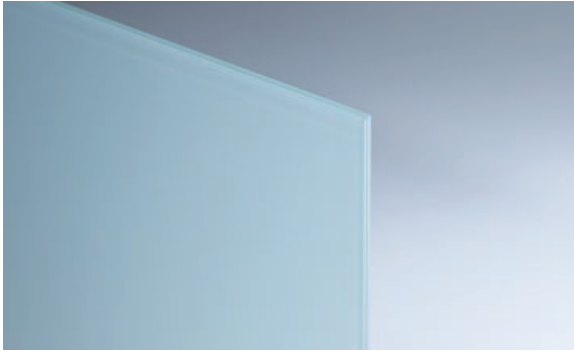

Milky White Laminated Glass

Laminated glass is two or more lites (pieces) of glass permanently bonded together with one or more plastic interlayers (PVB: polyvinyl butyral film) using heat and pressure. Laminated glass can be broken, but the fragments will tend to adhere to the plastic layer and remain largely intact, reducing the risk of injury.

Application: Closet doors, kitchen cabinets, bathroom windows.

Glass Thickness		Makeup / Composition	VLT%	SHGC	Winter U-Factor
mm	inches				
6.76mm	1/4"	1/8" Clear Glass + 0.030"White PVB + 1/8" Clear Glass	63	0.65	1.00
8.28mm	5/16"	1/8" Clear Glass + 0.090"White PVB + 1/8" Clear Glass	50	0.58	0.96
12.28mm	7/16"	3/16" Clear Glass + 0.090"White PVB + 3/16" Clear Glass	57	0.59	0.94



Gray/White Laminated Glass

Laminated glass is two or more lites (pieces) of glass permanently bonded together with one or more plastic interlayers (PVB: polyvinyl butyral film) using heat and pressure. Laminated glass can be broken, but the fragments will tend to adhere to the plastic layer and remain largely intact, reducing the risk of injury.

Application: Closet doors, kitchen cabinets, bathroom windows.

Glass Thickness		Makeup / Composition	VLT%	SHGC	Winter U-Factor
mm	inches				
8.28mm	5/16"	1/8" Gray Glass + 0.090" Milk White PVB + 1/8" Gray Glass	39	0.54	5.46
12.28mm	7/16"	3/16" Gray Glass + 0.090" Milk White PVB + 3/16" Gray Glass	24	0.46	5.34

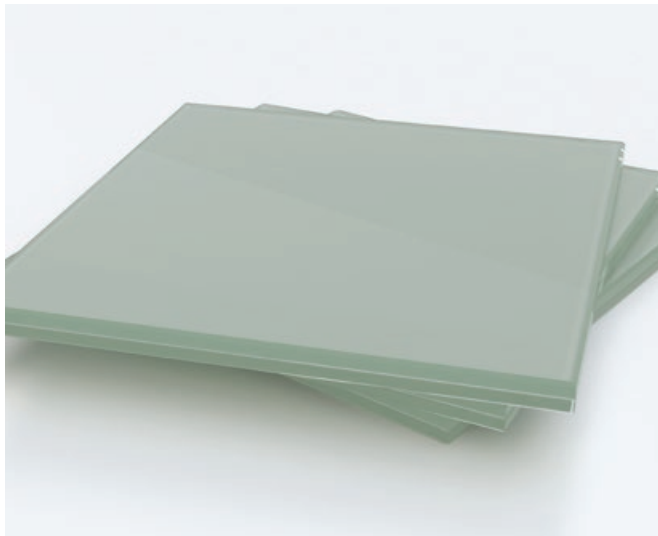



MIRRORS

Meets Standards:

ASTM C1503

Copper-Free Mirror: This is the most corrosive resistant silver mirror in the market. It is used in doors, wall covering, retail displays and fixtures, furniture and case goods, surfaces and tables. Available in clear, low iron, bronze, and gray tints.



Clear Mirror

This is the most common silver mirror which provides unparalleled protection against corrosion, chemicals moisture and abrasion while adding beauty and elegance to any room. It is used indoors in, wall coverings, retail displays and fixtures, furniture and showcases, surfaces and tables, vanities and more.

Benefits of Using Clear Mirror:

Excellent resistance to humidity. Strong performance in accelerated corrosion testing, including CASS and salt spray. Higher resistance to a wide range of household chemicals than traditional copper-manufactured mirrors. Reduced clouding due to copper oxidation, yielding a superior mirror product. Contributes to environmental protection by elimination of toxic products (i.e. Copper, ammonia and lead) during production. Improved resistance to aggressive agents in certain cleaning products.

Characteristic	Technical Requirements
Size Tolerance	± 2.0mm
Thickness tolerance	±0.3mm
Diagonal Difference	<diagonal average length's 0.2%
Performance:	
Silver content in silver film	≤800 mg/m ²
Lead content silver film	≤100mg/m ²
Silver film's pencil hardness	≥2H
Protective layer adhesion	Row lattice method ≤ 2 grade.
Slat Spray test	Allow color fade in protective layer but not allowed bubbles in the surface: reflective layer doesn't allowed fade or muddy, 0.3 ≤ stain diameter >0.2 mm, allowed qty: 2, edge corrosion ≤ 1.5mm
Heat-resisting/moisture-proof	Reflective layer without fade Back paint not dropped
Visible light reflectivity	≥85



LOW IRON MIRROR



Low-Iron Mirror

Low-Iron Mirror is characterized by a higher transparency and more neutral color, making it ideal where high reflection and clarity are required. Some of the features of this type of mirror are: brighter reflections, sharper focus, clearer images, better color, natural skin tones, whiter whites. Is use in most high-end places like spas, salons and retail spaces.

Benefits of Using Low Iron Mirror:

Due to its superior clarity, Low Iron Mirror reduces the greenish tint found in regular mirrors. This allows it to have greater enhanced clarity. True Color Reflection makes a significant difference as colors are reflected more accurately. This is the reason why Low Iron Mirror's are used in dressing rooms, makeup studios or art galleries. Low Iron mirror provides aesthetic superiority making the product be more appealing in modern designs. Durable and Long-lasting are one of the key benefits of using Low-Iron Mirrors.

Characteristic	Technical Requirements
Size Tolerance	±6.0mm
Thickness tolerance	±0.2mm
Diagonal Difference	Less than 0.2% diagonal average length
Performance:	
Silver content in silver film	≥730mg/m ²
Lead content silver film	
Silver film's pencil hardness	≥2H
Protective layer adhesion	Grid determination≤2 grade
Slat Spray test	Allow discoloration on the protective layer, not allow bubble on surface Not allow discoloration or turbidity on the reflective layer 0.3≤Spot diameter>0.2mm Allow 2 Edge corrosion≤1.5mm
Heat-resisting/moisture-proof	Reflective film color not change Back paint without peeling
Visible light reflectivity	≥90





Gray Mirror

Gray Mirror is a very modern decorative tinted mirror and a great way to incorporate a sleek masterpiece of low-keyed eloquence into one's mirror decor. Transform your space with an elegant reflection found only in the most sophisticated of spaces. With its cool tone it is popular in modern closets, and spaces like restaurants and elevators.



Bronze Mirror

Bronze Mirror is a very modern decorative mirror and great way to incorporate a sleek copper hue into one's mirror decor. Popular in fancy restaurants and bars, stylish bathrooms and in the home. Transform your space with an elegant reflection found only in the most sophisticated of spaces. Provides a warm tone finish.

Characteristic	Technical Requirements
Size Tolerance	± 2.0mm
Thickness tolerance	±0.3mm
Diagonal Difference	<diagonal average length's 0.2%
Performance:	
Silver content in silver film	≤800 mg/m ²
Lead content silver film	≤100mg/m ²
Silver film's pencil hardness	≥2H
Protective layer adhesion	Row lattice method ≤ 2 grade.
Slat Spray test	Allow color fade in protective layer but not allowed bubbles in the surface: reflective layer doesn't allowed fade or muddy, 0.3 ≤ stain diameter >0.2 mm, allowed qty: 2, edge corrosion ≤ 1.5mm
Heat-resisting/moisture-proof	Reflective layer without fade Back paint not dropped
Visible light reflectivity	≥85





Antique Mirror (French)

Antique Mirror is designed to offer a subtle retro appearance in any interior scheme. Offering a warm reflection high versatility. Can be used in a range of applications like large wall spans in interiors, lobbies, stylish commercial interiors, restaurants and bars, antique furniture, etc.

Some of the advantages of having antique mirror include: It's authentic decorative appearance, high durable and easy to maintain and safety makes Antique Mirror one of the most popular choices for interior design. Following the standard EN 1036, Antique mirror is for internal use only.

Offering a subtle and warm light, antique mirror is a highly versatile and can be applied in a range of applications to suit the designer and offer limitless design opportunities when combined with other materials such as wood, metal and marble.

Available in 1/4" (6mm) thickness only.

Antique Mirror (Taiwan)

Antique Mirror adds a subtle retro charm to any interior, offering a warm reflection and remarkable versatility. Ideal for large wall spans, lobbies, stylish commercial spaces, restaurants, bars, and antique furniture, it complements a variety of design aesthetics.

Key benefits of Antique Mirror include its authentic decorative appeal, durability, easy maintenance, and safety, making it a top choice for interior design. It complies with EN 1036 standards and is intended for internal use only.

With its gentle, warm light, Antique Mirror provides limitless design possibilities. It pairs beautifully with materials like wood, metal, and marble, allowing designers to create striking and sophisticated spaces.

Available in 1/4" (6mm) thickness only.





Satin Bronze Mirror

The Bronze Satin Mirror combines a warm bronze hue with a smooth satin finish, offering a unique blend of elegance and sophistication. The satin surface softly diffuses light, reducing glare and creating a refined, modern aesthetic.

This versatile mirror is perfect for a wide range of applications, including:

Interior Design: Enhances residential and commercial spaces with a touch of warmth and style, ideal for wall cladding, partitions, and decorative accents.

Furniture Integration: Adds a luxurious finish to custom furniture such as cabinets, tables, and wardrobes.

Bathrooms and Vanities: Ideal for creating sophisticated vanity mirrors and bathroom decor with a soft, elegant aesthetic.

Office Spaces: Suitable for modern office partitions, meeting rooms, and decor elements, offering a professional yet stylish look.

Available in 1/4" (6mm) thickness only.

Gray Satin Mirror

The Gray Satin Mirror combines a sleek gray tint with a smooth satin finish, delivering a modern and understated elegance. The satin surface diffuses light gently, reducing glare while maintaining a sophisticated and contemporary appearance.

This versatile mirror is ideal for a variety of applications, including:

Interior Design: Adds a cool, modern touch to residential and commercial spaces, perfect for wall cladding, partitions, and decorative accents.

Furniture Integration: Enhances custom furniture pieces like cabinets, tables, and wardrobes with a subtle and stylish finish.

Bathrooms and Vanities: Ideal for vanity mirrors and bathroom decor, offering a contemporary aesthetic with a soft, diffused appearance.

Office Spaces: Perfect for modern office partitions, meeting rooms, and decor elements, adding a professional and sleek look.

Available in 1/4" (6mm) thickness only.



Satin Low-Iron Mirror

A premium decorative glass with a low-iron base and satin-etched surface, offering true color clarity and a soft, diffused reflection. Unlike standard mirrors, it eliminates the greenish tint, providing a modern and elegant finish.

This versatile mirror is ideal for a variety of applications, including:

Wall Cladding: Enhances commercial and residential interiors.

Furniture & Cabinetry: Ideal for wardrobe doors, shelving, and décor.

Partitions: Offers privacy while maintaining brightness.

Bathrooms & Dressing Rooms: Perfect for luxury vanities and refined interiors.

Available in 1/4" (6mm) thickness only.



ONE-WAY MIRROR/DIAMOND POLISHED WIRE GLASS



One-Way Mirror

One-Way Mirror is a reflective coated glass which offers an effective means of providing undetected surveillance and high quality one-way vision to achieve complete privacy. Ideally used in interrogation rooms, computer rooms, banks or cash offices. This glass must be installed with the coating on the subject's (observed person) side.

Some of the most important characteristics of One Way Mirror include:

- 1. Transparency and Reflection:** The coating in the mirror allows it to be reflective and transparent due to its transparent layer of metal.
- 2. Lighting Conditions:** One-Way Mirror relies on lighting conditions on either side.
- 3. Directional Privacy:** One-Way Mirrors are used for privacy features, in areas where security is promoted. People on one side can see through but on the other side they can only see their reflection.
- 4. Versatility:** One Way Mirrors are used in various areas like entertainment, technology and scientific research.
- 5. Thickness and Durability:** This glass varies in thickness and has different applications.

Glass Thickness		Optical Performance	Solvent Resistance	Alkali Resistance	Acid Resistance	Hot & Humid	Salt Spray Test	Adhesive Force	Thickness Tolerances	Length/Width Tolerances
mm	inches									
6mm	1/4"	Film surface reflection 30+ -3% glass surface reflection 60 +- 3% transmission 10 +- 3%	25°C 72 Hours	40°C 5% NaOH, 1 Hours	25°C, 5% H ₂ SO ₄ , to 24 Hours	85°C 85%RH 48 Hours	Neutral salt spray test, 5%NaCl salt solution, PH 6.5-6.8 96h 48hCASS test PH 3.1-3.3 Copper accelerates acetate spray 48h	Strip bottom test with 3M tape	+/-0.2mm	+/- 1mm

In inspection the film layer does not fall off
Result: Qualified and meets the required standards.



Diamond Polished Wire Glass

A clear annealed glass with a (1/4") diamond patterned wire mesh embedded into the substrate, offering fire protection with a modern industrial aesthetic.

Where to Use It?

- **Doors & Windows:** Fire-rated applications without impact resistance.
- **Cabinetry & Partitions:** Industrial & farmhouse aesthetics.
- **Fire-Rated Doors & Frames:** Must meet safety standards.

Glass Thickness		Makeup / Composition	VLT%	SHGC	Winter U-Factor
mm	inches				
6mm	1/4"	1/4" Polished Diamond Glass	83,7	0,92	0.81



GLAZING TOOLS

GLASS FABRICATION TOOLS

Water Resistant Labels

NS-2000

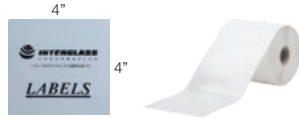

500 labels per roll specially designed for the glass industry. Easy to peel off. Water resistant. Label size 4" x 4". Recommended use with thermal printer Zebra GK420T. Glossy Finish.
Available for purchase by full pallet.

Gauntlet Cuff Palm Gloves (Pair)

GT-GG01



Special smooth, natural rubber coating on the palm side with freedom of hand movement.

Foam pad Red

?

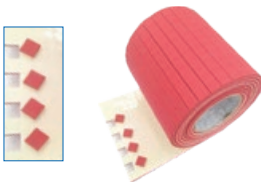

Cork pads with static foam (non-adhesive) for separating glass, designed to peel off cleanly without leaving residue.

Wood Crate Slings

SL120281



For wood cases handling using a 10,000 lbs forklift boom or 3 Ton overhead crane. Adjustable for 48" x 84" up to 96" x 144" cases.

Stick-On Sanding Discs



Disc Size	Grit	Code
5"	80 Grit	PSA580
6"	80 Grit	PSA680
5"	120 Grit	PSA5120
6"	120 Grit	PSA6120
6"	400 Grit	PSA6400

CRL Abrasive Sanding discs to use with the Makita GV5010 Disc Sander, or similar. Use to grind or polish glass or mirrors edge.

Tuff-N-Lite® Halo Interlock Jacket

JAJNT241L
JAJNT241XL



- Full body zipper jacket with abdominal cut reinforcement.
- Uses Complex Ultra-Light Yarn Blends.
- Unaffected by moisture or UV radiation.
- Keeps user cool in hot conditions.
- Available in sizes L and XL

Tuff-N-Lite® Gripper Gloves

GL668M
GL668L
GL668XL



- Rubber-coated grip pattern provides excellent wet & dry grip.
- Comfortable, cut-resistant composite liner for all-day wear.
- Available in sizes M, L, and XL

CRL 124" Glass Slings



Durable and easy to use, these glass slings are designed to safely lift and handle large glass panels with confidence in everyday jobsite conditions.

Stick-On Disc Replacement



Attach this pad to the Makita disc sander to be able to use adhesive discs. For 6" discs only.

Pad 6"	For 6" discs only	PAD6
Pad 5"	For 5" discs only	PAD5

Cork Separator Pads



Cork pads with static foam (Non-Adhesive) for separating glass. Peels off without leaving residue.

Pad Size: 3/4" x 3/4"	
1/8" Thick (25,000/roll)	NS-303
1/4" Thick (11,667/roll)	NS-306
Pad Size: 1" x 1"	
3/16" Thick (9,500/roll)	NS-305

Polishing Spray Oil

CRL920



Contents: 11 oz Can.
Polishing oil used to lubricate the belts or sanding discs for a smooth clear finish.

Diamantor Glass Cutter

BO-200.1



DIAMANTOR

One steel wheel with 130° cutting angle. Straight edge stand-off distance 1/16" (1.5mm). Disposable. Wood handle. For 3/32" (2.3mm) up to 1/4" (6mm) glass.

GLASS & MIRROR INSTALLATION TOOLS

Palmer Superset Mirro-Mastic® (100Z Cartridge)

PMSS



A high quality, low VOC, solvent-free adhesive mastic. SuperSet Mirro-Mastic is formulated for adhering acrylic and glass mirror to various substrates. SuperSet qualifies for LEED® Green Building Rating System™ credit.

Available for purchase by full pallet.

Palmer Mirro-Mastic® Cartridge

PM601T



Palmer Mirro-Mastic® Can

PM201GL



This mirror adhesive will not damage mirror silvering. Stays live and won't crack or dry. Allows movement due to normal thermal changes. Qualifies for LEED. Fully cures in 45 days.

Available for purchase by full pallet.

CRL Nickel Plated Mirror Clips

778A

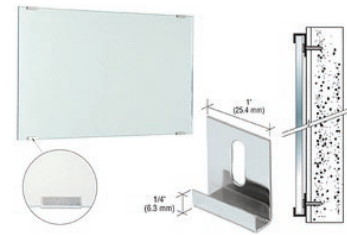

1/4" Mirror (Box of 100)

These Mirror Clips are available in a nickel-plated finish. The advantage of the nickel-plated finish is its resistance to corrosion. They are designed with 1" (25.4 mm) slots allowing height adjustment during installation. They are available for 6.3 mm (1/4") glass thicknesses.

Mounting Foam Tape

CRL423212

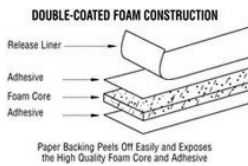

Color: Black

Size: 1/32" Thick x 1/2" Wide x 200" Length. Double Face Tape to mount mirrors on various surfaces. Chemically compatible with all coatings and will not cause ghosting.

L-Channel Moulding

L-CH12D

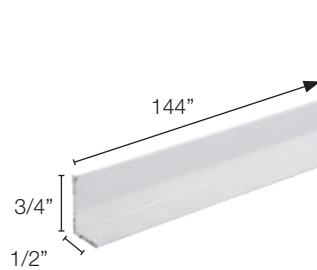

BA
MB

Material: Aluminum

L-Mouldings can be used for inside and outside corners. Use it on wall mirrors where a lower lip is not required.

Safety Back Tape

SBT48

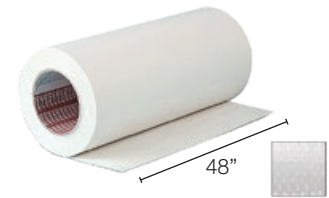

Size: 48" Width x 250' Length

Category II Tape makes Mirrors Shatter Resistant. Keeps glass fragments from causing serious bodily damage. This pressure-sensitive, adhesive coated film tape is primarily recommended for mirrored closets or walls.

Complies with: ANSIZ97.1-2009.
16CFR1201

Deep J-Channel Moulding

J-CH12D

BA
MB

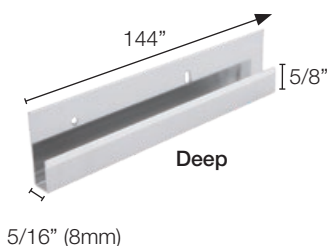

Shallow J-Channel Moulding

J-CH12W

BA
MB

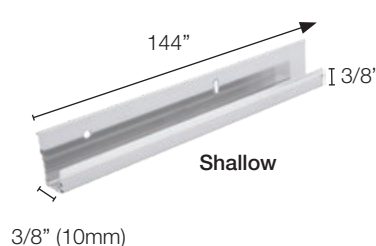

Material: Aluminum
Stock Length: 144"

J-Moulding are designed to be used below or on top of 1/4" mirror and allows for irregular wall surfaces.

It provides extra room for application of light bodied mirror mastics or foam mirror mounting tapes when using the Deep Moulding. Full body Mirro-Mastic can only be used with the Shallow Moulding.

GLASS & MIRROR INSTALLATION TOOLS

Oval Mirrors

M-602436

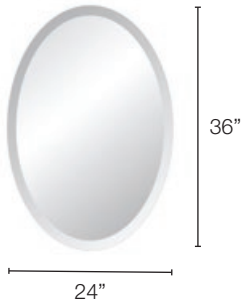

1/4" Oval Shape Copper-free Mirror with 1" bevel. Mostly used in bathrooms. Does not include mounting hardware.

Beveled Mirror Strips

S-6R2120
S-6R3120

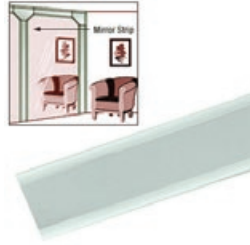

Available in:
2" x 120"
3" x 120"

Single Acrylic Mirror Outlet Plate

PMP102



Double Acrylic Mirror Outlet Plate

PMP202



Material: 1/8" Mirror-Backed Acrylic. Covers Switch and Outlets. Drilled for standard size mounting screws.

Plastic Setting Blocks

PSB040



Support blocks for frameless installation or inside u-channel.
Dimensions: 1/16" H x 1/4" W x 2" L

Mildew Resistant Clear Silicone Sealant

33SMRC



Contents: 10 oz Cartridge
General purpose acetoxycure clear silicone sealant/adhesive. Mildew resistant; making it perfect for shower enclosures. It is a one component, room temperature curing, 100% silicone elastomer that does not require activators, stabilizers or catalysts to achieve optimum performance.

Substrates: Glass, aluminum, fiber glass, tile, plastic, ceramic, masonry, concrete, brick and wood.

Available for purchase by full pallet.

Wood's Powr-Grip® ABS 8" Suction Cup

B0-6023157



Model G0695. Lightweight, heavy duty handle made of rustproof ABS. Red-line indicator warns user of any significant vacuum loss. Vacuum Pad: 8" [20 cm] diameter. Load Capacity: 125 lbs (56 Kg)

Spear Point Drill Bit



Ceramic/Glass drill bit for use in hand held low rpm power tools.

3/16" [BA-5000905](#)

1/4" [BA-5000906](#)

Single Edge Razor Blades

51S



Super sharp, disposable. Used for cleaning debris in glass. 3 facet blades can be oiled or degreased, depending on application.

Hi-Sheen Glass Cleaner

3371100



Contents: 19 oz Can
Industrial strength glass cleaning. Foaming action stays on the glass longer for better results. Ozone safe. HAZMAT, not available for export.
[Available for purchase by full pallet.](#)

Bio-Clean Water Stain Remover

WSR1



Contents: 16 oz Bottle.
Helps removes water and mineral stains, lime scale, calcium, soap scum, among others from glass and other surfaces. Works great on: shower doors, windows, chrome, aluminum, stainless steel, etc

TPC Surface Protector

TPC16



Contents: 16 oz
Transparent polymer coating that prevents buildup, improves scratch resistance by 75%, bonds instantly to glass, porcelain, and ceramics, won't discolor or build up, and can be retreated anytime. Compatible with non-abrasive cleaners.

Premium Microfiber Cloths

MF1616GCB



16" X 16" Blue, 44GSM (pack of 12).
Premium Glass Cloths are great for cleaning and polishing all glass and metal surfaces for a streak - free and lint - free finish. The ultra fine fibers grab onto tiny surface contaminants while polishing wet or dry.

Spunlace Lint free Wipe

CDFP1



12" x 12" Extra-tough Lint - free Cloth-like Fabric (Pack of 250), use instead of paper towels. Solvent Resistant, creped Texture, high wet/dry strength, and absorbent. Use these wipes to clean solid surfaces like, glass, tiles, ceramics, mirrors and much more.





SHOWER HARDWARE

3/8" Clear Tempered Glass Shower Door For Standard Wall Hinge

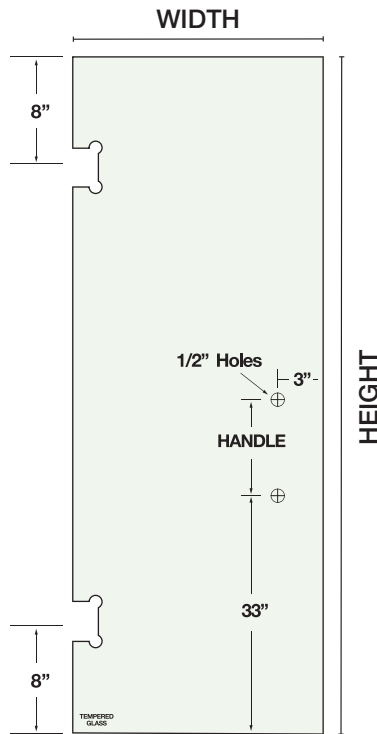

ITEM #	WIDTH	HEIGHT	HANDLE
D-7224	24"	71-5/8"	8"
D-7226	26"	71-5/8"	8"
D-7228	28"	71-5/8"	8"
D-7626	26"	75-5/8"	8"
D-7628	28"	75-5/8"	8"
D-8026	26"	79-5/8"	8"
D-8028	28"	79-5/8"	8"

Compatible With The Following Hinges

Z-2000	Z-3111	Z-3113	Z-7515
Z-3120	Z-3020	Z-9430	

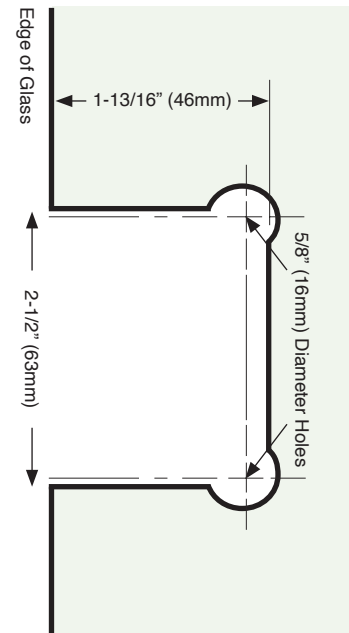

Cut-out Tolerance: +/- 1/16" (2mm)
 Door Tolerance: 1/4" (6mm) Bow
 Conformance with: ASTM C1048-12

3/8" Clear Tempered Glass Shower Door For Heavy-Duty Wall Hinge

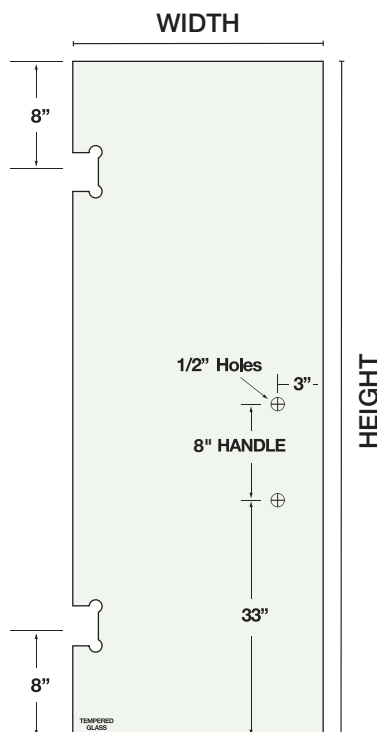

ITEM #	WIDTH	HEIGHT	HANDLE
DH-7628	28"	75-5/8"	8"
DH-8028	28"	79-5/8"	8"
D-8426	26"	83-5/8"	8"
D-8428	28"	83-5/8"	8"

Compatible With The Following Hinges

Z-9111	Z-9113	Z-9712	Z-9120
--------	--------	--------	--------

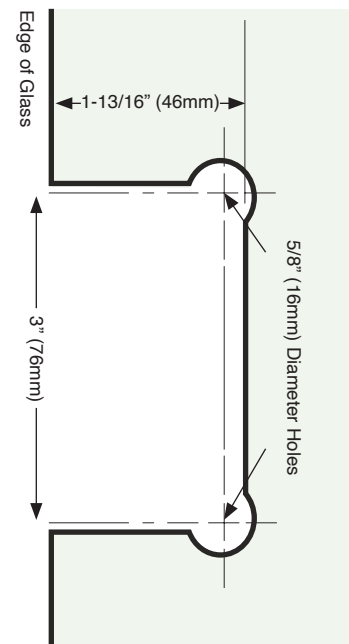

Cut-out Tolerance: +/- 1/16" (2mm)
 Door Tolerance: 1/4" (6mm) Bow
 Conformance with: ASTM C1048-12



WALL MOUNT HINGES

Glass Requirements

- 3/8" (10mm) Tempered Glass
- 1/2" (12mm) Tempered Glass



Specifications

- Solid brass body and clear polyurethane gaskets
- Glass cut-out required
- Screws and gaskets included
- Hinge swings 90° in and 90° out
- Self-centering when within 15° of closed position
- Use thick gaskets for 3/8" glass or thin gaskets for 1/2" glass

Cares

- Can be cleaned with water and a soft cloth
- Use of harsh or abrasive cleaners may harm finish and will void the warranty
- Do not use power tools when installing or spray lubricant on this hinges
- 3 year warranty on Hinges only, all other hardware 1 year warranty



WALL MOUNT HINGES

Wall Mount H-Back Square Hinge

Z-2000



- CP
- BN
- MB
- BG

Wall Mount H-Back Beveled Hinge



Z-3012

- CP
- BN
- MB
- BG

Wall Mount Full-Back Square Hinge



Z-3111

- CP
- BN
- MB

Wall Mount Offset-Back Square Hinge



Z-3113

- CP
- BN
- MB
- BG

Tight Clearance Cut-Out Wall Deduction: 1/16" (2mm)

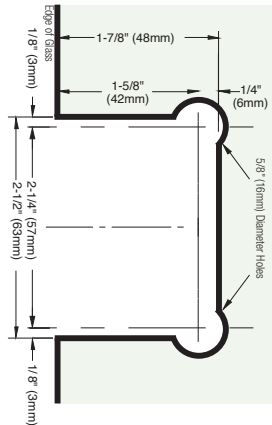

Optional:
Standard Glass Cut-out with 3/16" deduction

Standard Glass Cut-Out Wall Deduction: 3/16" (5mm)

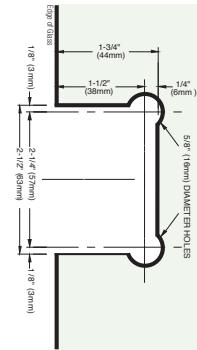

Wall Mount Full-Back Adjustable Beveled Hinge

Z-7515



- CP
- BN
- MB
- BG

Maximum Door Capacities

2 Hinges | Weight: 75 lbs (34 Kg) | Width: 28" (711mm)
For a heavier load use heavy duty hinges

Heavy-Duty Wall Mount Full Back Square Hinge

Z-9111



- CP
- BN
- MB
- BG

Heavy-Duty Wall Mount H-Back Square Hinge



Z-9117

- CP
- BN
- MB
- BG

Heavy-Duty Beveled Wall Mount H-Back Hinge



Z-9012

- CP
- BN
- MB
- BG

Heavy-Duty Glass Cut-Out Wall Deduction: 3/16" (5mm)

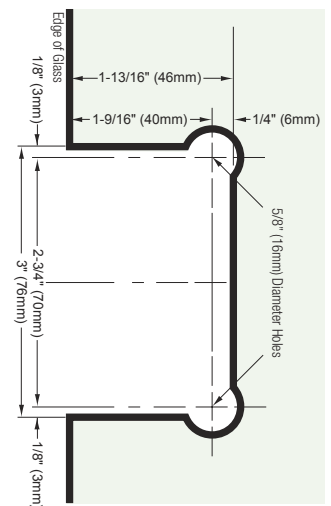

Maximum Door Capacities

2 Hinges | Weight: 110 lbs (50 Kg) | Width: 36" (914mm)
3 Hinges | Weight: 140 lbs (63 Kg) | Width: 36" (914mm)

Heavy-Duty Wall Mount Offset Back Square Hinge

Z-9113-1



- CP
- BN
- MB
- BG

Heavy-Duty Wall Mount H-Back Adjustable Beveled Hinge



Z-9712

- CP
- BN
- MB
- BG

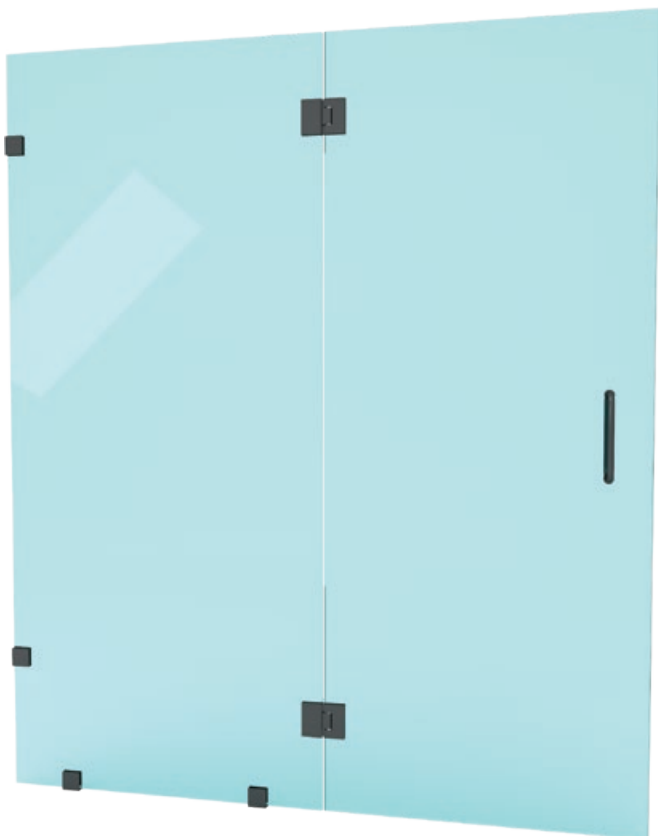

GLASS TO GLASS HINGES

Glass Requirements

- For 3/8" (10mm) Tempered Glass
- For 1/2" (12mm) Tempered Glass



Specifications

- Solid brass body and clear polyurethane gaskets
- Glass cut-out required
- Screws and gaskets included
- Hinge swings 90° in and 90° out with self-centering
- Self-centering when within 15° of closed position
- Use thick gaskets for 3/8" glass or thin gaskets for 1/2" glass

Cares

- Can be cleaned with water and a soft cloth
- Use of harsh or abrasive cleaners may harm finish and will void the warranty
- Do not use power tools when installing or spray lubricant on this hinges
- 3 year warranty on Hinges only, all other hardware 1 year warranty

Glass-to-Glass 180° Square Hinge

Z-3120



Glass-to-Glass 180° Beveled Hinge

Z-3020



Glass-to-Glass 135° Adjustable Square Hinge

Z-9430



Standard Glass Cut-Out

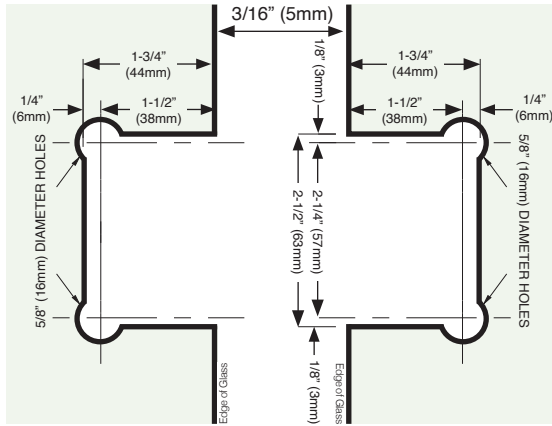

Standard Glass Cut-Out

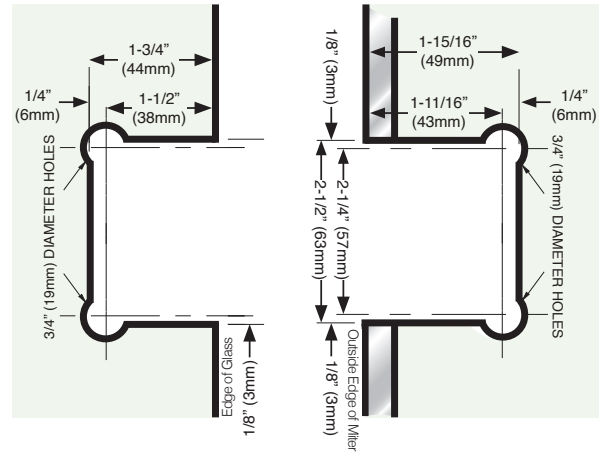

Maximum Door Capacities

2 Hinges | Weight 75 lbs (34 Kg) | Width 28" (711mm)

For a heavier load use heavy duty hinges

Heavy-Duty Glass to Glass 180° Square Hinge

Z-9120



Heavy-Duty Glass Cut-Out

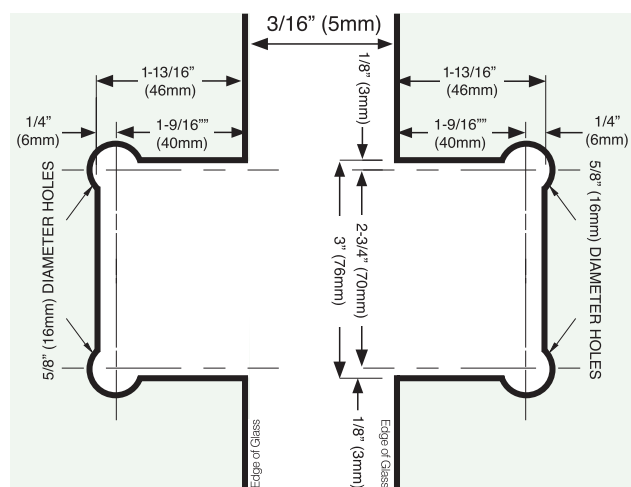

Maximum Door Capacities

2 Hinges | Weight 110 lbs (50 Kg) | Width 36" (914mm)

3 Hinges | Weight 140 lbs (63 Kg) | Width 36" (914mm)

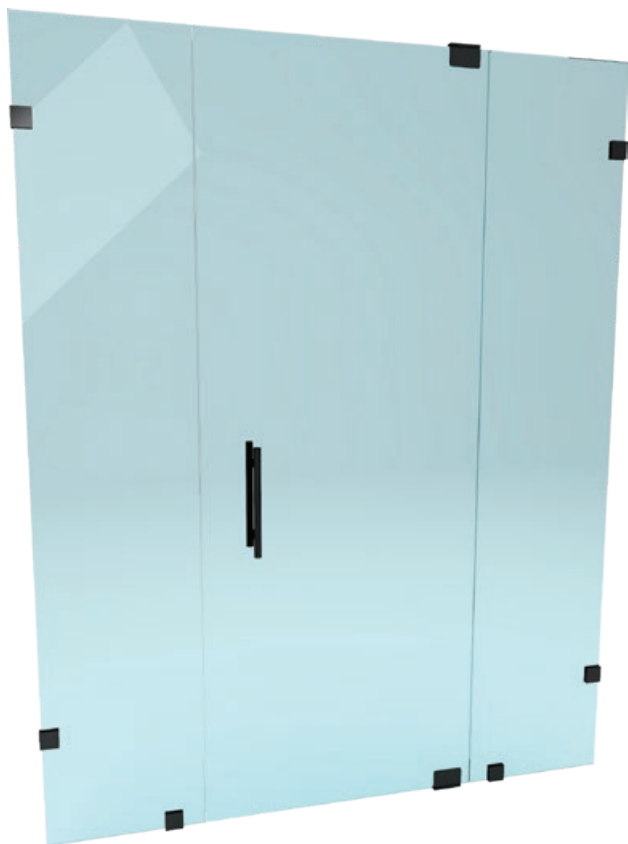

PIVOT HINGES

Specifications

- Solid brass body and clear polyurethane gaskets
- Glass cut-out required
- Screws and gaskets included
- Hinge swings 90° in and 90° out. Self-centering when within 15° of closed position
- Can be mounted floor and ceiling, or floor and wall using the wall adaptor (Z-3835), or adaptor block (Z-HAB01)



Cares

- Clean with water and a soft cloth
- Use of harsh or abrasive cleaners may harm finish and will void the warranty
- Do not use power tools directly on the hinge when installing or spray lubricant on this hinges
- 3 year warranty on Hinges only, all other hardware 1 year warranty

Pivot Square Hinge

Z-3820



- CP
- BN
- MB**
- BG

Pivot Beveled Hinge

Z-3830



- CP
- BN
- BG**

Standard Pivot Wall Adapter

Z-3835



- CP
- BN
- MB**
- BG

Allows Standard Pivot Hinge (Z-3830 or Z-3820) to be left or right hand wall mounted. Without the need of a header.

Standard Glass Cut-Out Deduction: 3/8" (10mm)

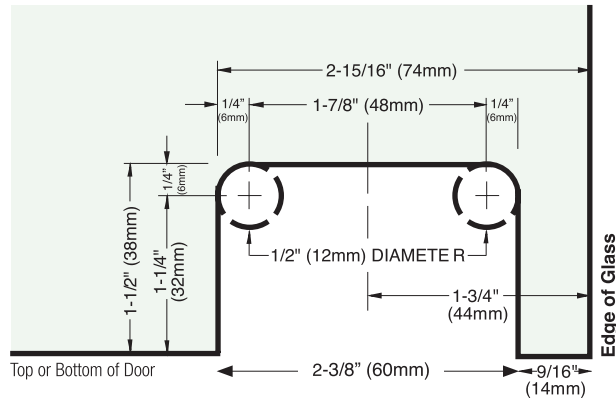

Maximum Door Capacities

2 Hinges | Weight 100 lbs (45 Kg) | Width 31" (787mm)

Glass Requirements

- 3/8" (10mm) Tempered Glass

Heavy-Duty Pivot Square Hinge

Z-3828



- CP
- BN
- MB**

Heavy-Duty Pivot Beveled Hinge

Z-3838



- CP
- BN
- MB**
- BG

Heavy-Duty Glass Cut-Out Deduction: 9/16" (13mm)

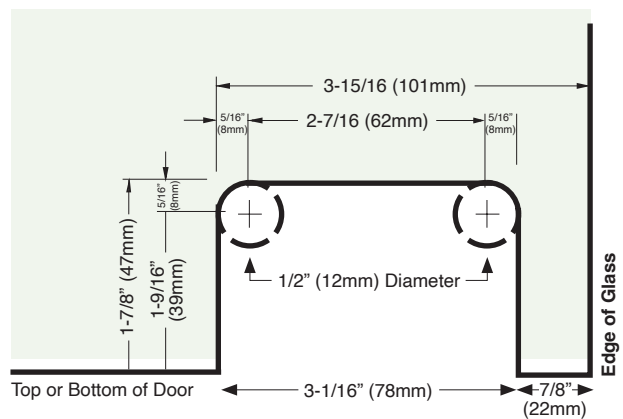

Maximum Door Capacities

2 Hinges | Weight 145 lbs (66 Kg) | Width 36" (914mm)

Glass Requirements

- 3/8" (10mm) Tempered Glass
- 1/2" (12mm) Tempered Glass

HANDLES & TOWEL BARS

Tubular 6" Handle

Z-5310A

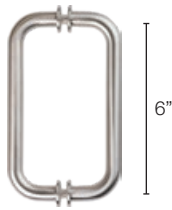

- CP
- BN
- MB

Square 6" Handle

Z-5303A

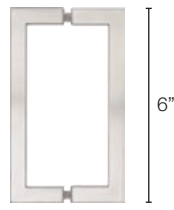

- CP
- BN
- MB

Tubular Ladder 8" Handle

Z-5313B

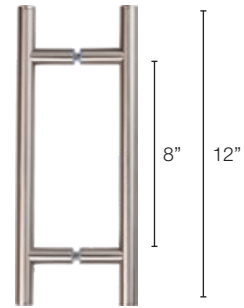

- CP
- BN
- MB
- BG

Tubular 8" Handle

Z-5310B

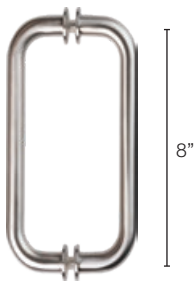

- CP
- BN
- MB
- BG

Square 8" Handle

Z-5303B

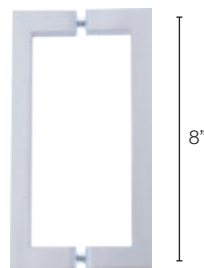

- CP
- BN
- MB
- BG

Square Ladder 8" Handle

Z-2043B

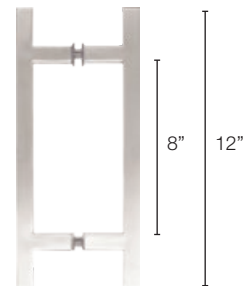

- CP
- BN
- MB

Tubular 24" Towel Bar

Z-5320B



- CP
- BN
- MB

Square 24" Towel Bar

Z-5329B

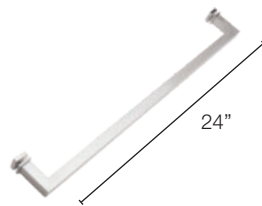

- CP
- BN
- MB

Handle/Towel Bar tubular 6"x18"

Z-5342



- CP
- BN

Tubular 8" Handle with 18" Towel Bar Combination

Z-5348



- CP
- BN
- MB

Square 8" Handle with 18" Towel Bar Combination

Z-5358

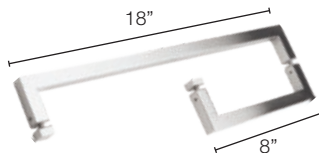

- CP
- BN
- MB

Square Knob

SK110

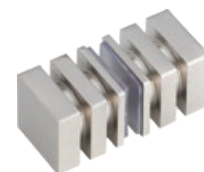

- CP
- BN
- MB

Material: Solid Brass

Glass Requirements

- 1/4" (6mm) Tempered Glass
- 3/8" (10mm) Tempered Glass
- 1/2" (12mm) Tempered Glass

Specifications

- Material: 3/4" (19mm) Stainless Steel
- Hole Diameter Required: 1/2" (12mm)

Cares

- Clean with water and a soft cloth
- Use of harsh or abrasive cleaners may harm finish and will void the warranty
- Do not use power tools directly on the handle when installing or spray lubricant

Rounded Knob

Z-5108



- CP
- BN

Material: Solid Brass

Square Fixed Panel Clamp

Z-4602

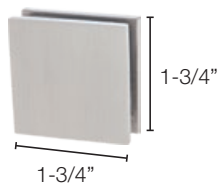

HOLE-IN-GLASS

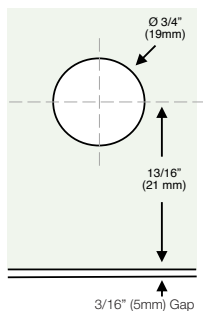

Cut-out used when hanging glass panel from ceiling.

Rounded Fixed Panel Clamp

Z-4401

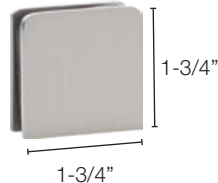

FINGER NOTCH GLASS CUT-OUT

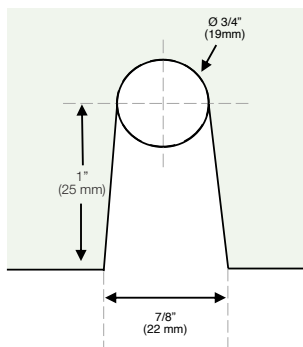

Cut-out used when fixing glass panel to wall or floor.

Heavy-Duty Square Fixed Panel Clamp

Z-4601

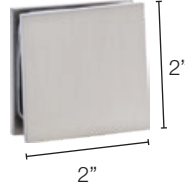

FINGER NOTCH GLASS CUT-OUT

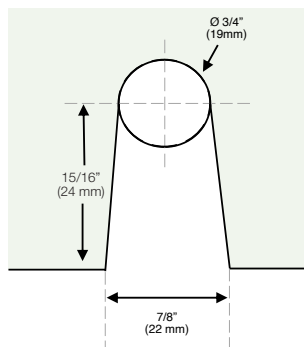

Heavy-Duty Beveled Fixed Panel Clamp

Z-4607

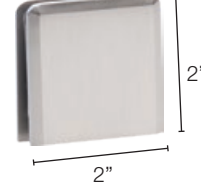

FINGER NOTCH GLASS CUT-OUT

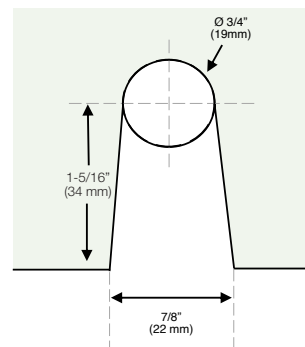

Heavy-Duty Square Fixed Panel Double Screw Clamp

Z-4603

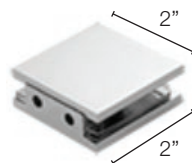

GLASS CUT-OUT

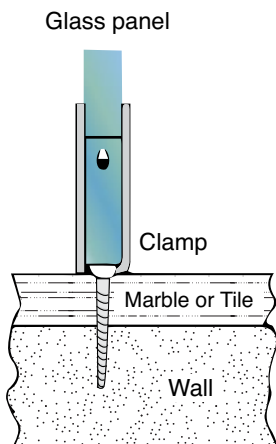
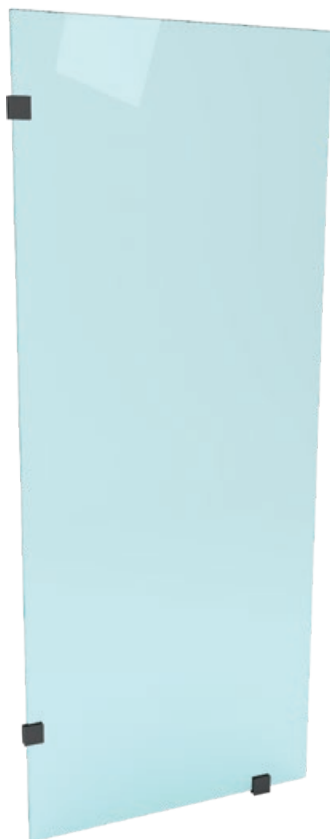
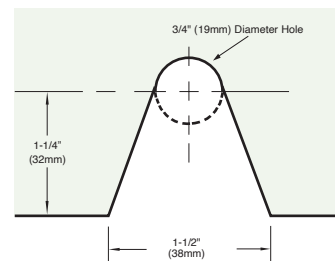

Glass Requirements

- 3/8" (10mm) Tempered Glass
- 1/2" (12mm) Tempered Glass

Specifications

- Solid brass body and clear polyurethane gaskets
- Screws and gaskets included
- Glass cut-out required

Cares

- Clean with water and a soft cloth
- Use of harsh or abrasive cleaners may harm finish and will void the warranty
- Do not use power tools directly on the clamp when installing or spray lubricant

GLASS TO GLASS CLAMPS

Glass-to-Glass 90° Rounded Clamp

Z-4425



Heavy-Duty Glass to Glass 90° Square Clamp

Z-4625



Flat Edge Glass Cut-Out

3/4" (19mm)
Diameter Hole

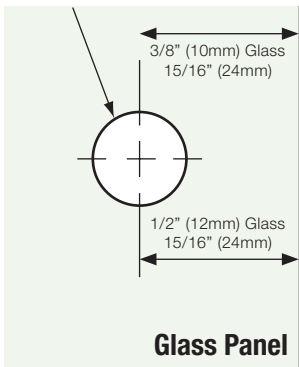

Butting Panel

3/4" (19mm)
Diameter Hole

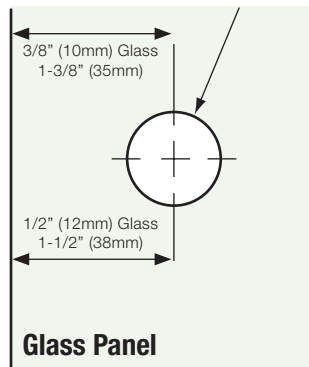

Overlapping Panel

45° Mitered Edge Glass Cut-Out

3/4" (19mm)
Diameter Hole

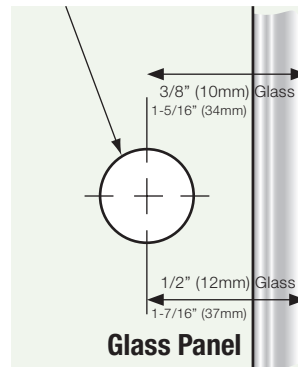

45° Mitered Panel

Outside Edge of Miter

3/4" (19mm)
Diameter Hole

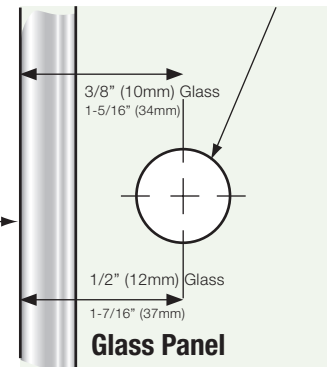

45° Mitered Panel



Glass Requirements

- 3/8" (10mm) Tempered Glass
- 1/2" (12mm) Tempered Glass

Specifications

- Solid brass body and clear polyurethane gaskets
- Screws and gaskets included

Cares

- Can be clean with water and a soft cloth
- Use of harsh or abrasive cleaners may harm finish and will void the warranty
- Do not use power tools directly on the clamp when installing or spray lubricant

Glass-to-Glass 135° Rounded Clamp

Z-4423



Glass-to-Glass 180° Rounded Clamp

Z-4420



22.5° Mitered Glass Cut-Out

3/4" (19mm) Diameter Hole Outside Edge of Miter 3/4" (19mm) Diameter Hole

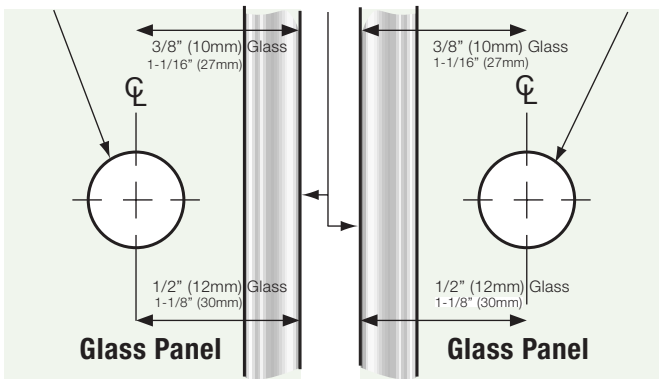

22.5° Mitered Panel

22.5° Mitered Panel



Glass Cut-Out

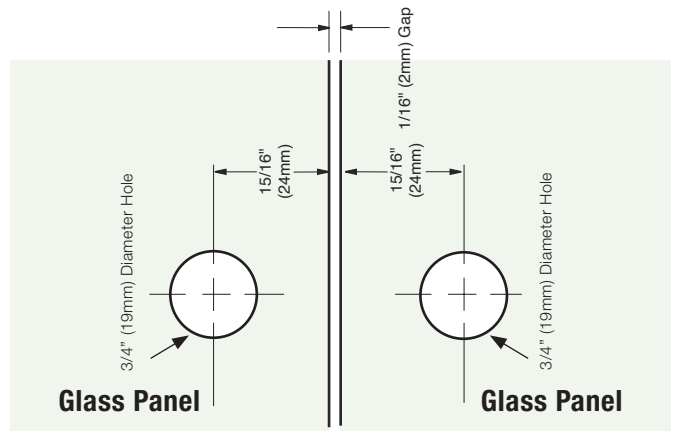

Glass Panel

Glass Panel



Glass Requirements

- 3/8" (10mm) Tempered Glass
- 1/2" (12mm) Tempered Glass

Specifications

- Solid brass body and clear polyurethane gaskets
- Screws and gaskets included

Cares

- Can be clean with water and a soft cloth
- Use of harsh or abrasive cleaners may harm finish and will void the warranty
- Do not use power tools when installing or spray lubricant on these clamps

NO HOLE CLAMPS

Sleeve Over Glass-to-Glass 90° Clamp

Z-CGC90



- CP
- BN
- MB
- BG

Sleeve Over Glass-to-Glass Adjustable Clamp

Z-CGCAD002



Adjustable from 90° to 180°

- CP
- BN
- MB



These Clamps are not designed to replace headers or support bars. Clamps are secured in place by set screws on the back

Sleeve Over Left Wall Mount Clamp

Z-SFM005L



Left handed as view from outside the shower

- CP
- BN
- MB
- BG

Sleeve Over Right Wall Mount Clamp

Z-SFM005R



Right handed as view from outside the shower

- CP
- BN
- MB
- BG



*Example of left Sleeve Over

These Clamps are not designed to replace headers or support bars. Clamps are secured in place by set screws on the back

Rounded Shelf Clamp

Z-SC12



Max 5" Glass Protution from wall is recommended, unless used in a corner shelf.

- CP
- BN
- MB
- BG

Corner Shelf Glass

T-SH10X10

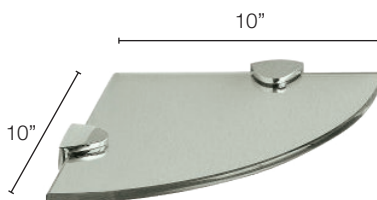

Tempered Safety Glass. Clamps not included.



Specifications

- Material: Solid Brass
- No holes required on Glass

Glass Requirements

- 3/8" (10mm) Tempered Glass
- 3/8" (10.38mm) Laminated Glass
- 1/2" (12mm) Tempered Glass

U-Channel 95" For 3/8" (10mm) Glass

Z-U10A



U-Channel 144" For 3/8" (10mm) Glass

Z-U10B



U-Channel 144" For 1/2" (12mm) Glass

Z-U12A

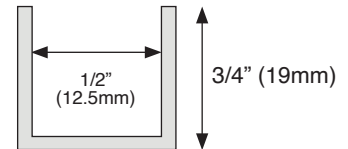
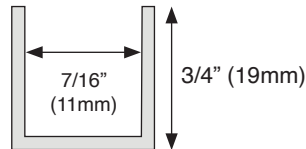

Glass Requirements

- 3/8" (10mm) Tempered Glass
- 3/8" (10.38mm) Laminated Glass

Glass Requirements

- 1/2" (12mm) Tempered Glass

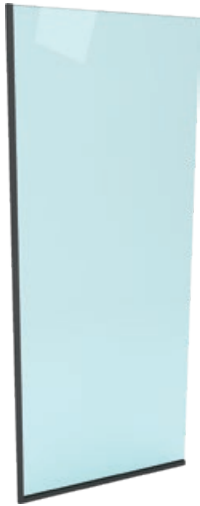

Specifications

- Material: Aluminium
- No holes required on Glass
- No pre-drilled holes in channel

Cares

- Can be clean with water and a soft cloth
- The use of harsh or abrasive cleaners may harm finish and will void the warranty



Wall-to-Glass Support Bar

Z-5431B

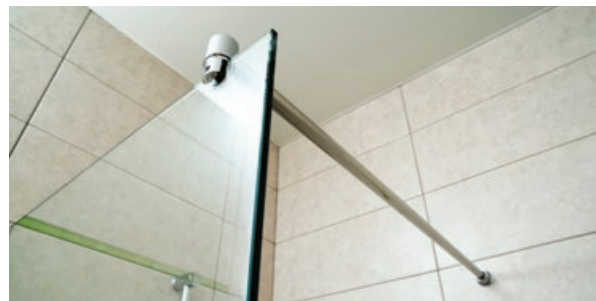

Material: Tubular Brass
No holes required on glass.
Stock bar length: 51"

Fixed panel support bar will stabilize glass that do not go all the way to the ceiling. Cut to size required.

Glass Requirements

- 3/8" (10mm) Tempered Glass
- 3/8" (10.38mm) Laminated Glass
- 1/2" (12mm) Tempered Glass

Shower Door Header Kit 98"

Z-SDH001A



- CP
- BN
- MB
- BG

Kit Includes

- Header 98" or 144" in length
- Snap-In Filler for Door Pocket 36"
- Gasket for 3/8" (10mm) Glass

Glass Requirements

- 3/8" (10mm) Tempered Glass
- 3/8" (10.38mm) Laminated Glass
- 1/2" (12mm) Tempered Glass

Cares

- Can be clean with water and a soft cloth
- The use of harsh or abrasive cleaners may harm finish and will void the warranty

Shower Door Header Kit 144"

Z-SDH001B



- CP
- BN
- MB
- BG

Will provide additional support and a level of safety while securing glass panels not reaching the ceiling. Highly recommended on Neo-Angle installations.

Specifications

- Material: Aluminum
- No holes required in Glass
- For 1/2" glass do not use vinyl gasket

Not Included in Kit

- Wall Brackets (Z-BW2)

Wall Mounting Brackets

Z-BWB2



For use with header. Sold in pairs. Includes: Mounting screw. Material: Solid Brass.

Adjustable Header Corner

Z-BHC373



For use with header when a corner is needed. Includes: Mounting screw. Material: Solid Brass.



Standard Adaptor Block

Z-HAB01



- CP
- BN
- MB
- BG

Allows Standard Pivot Hinge (Z-3830 or Z-3820) to be mounted into header. Includes: Mounting screw. Material: Solid Brass.

Neo-Angle Shower Enclosure Example



Inline 180° Side Seal Soft Leg For 3/8"

PS10

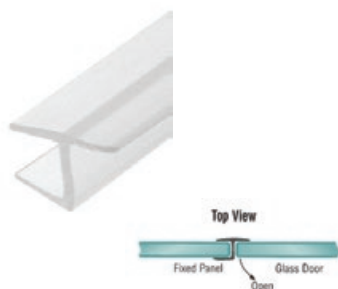

Snaps into Fixed Panel
Material: Polycarbonate
Stock Length: 98"
Glass Thickness: 3/8" (10mm)
Suggested Gap: 3/16" (5mm)

Inline 180° Side Seal Soft Leg for 1/2"

PS12

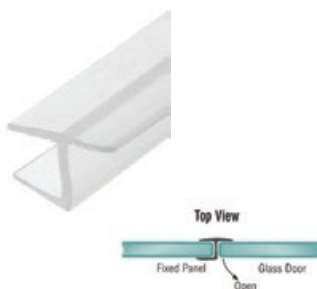

Snaps into Fixed Panel
Material: Polycarbonate
Stock Length: 98"
Glass Thickness: 1/2" (12mm)
Suggested Gap: 3/16" (5mm)

CRL Inline 180° Side Seal Hard Leg For 3/8"

P380HJ

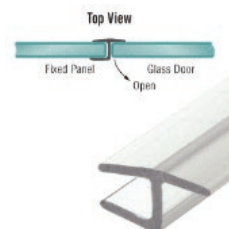

Snaps into a fixed panel
Material: Polycarbonate
Stock Length: 95"
Glass Thickness: 3/8" (10mm)
Suggested Gap: 3/16" (5mm)

Bottom Wipe With Drip Rail For 3/8"

PB10

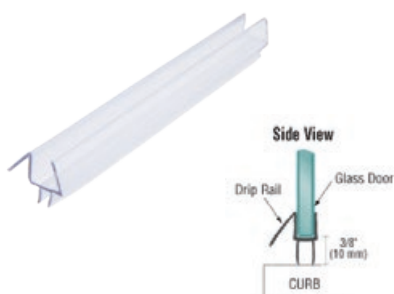

Snaps into bottom of door
Material: Polycarbonate
Stock Length: 98"
Glass Thickness: 3/8" (10mm)
Suggested Gap: 3/8" (10mm)

Bottom Wipe With Drip Rail For 1/2"

PB12

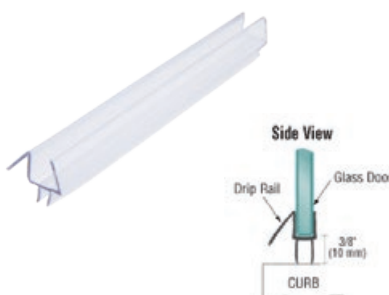

Snaps into bottom of door
Material: Polycarbonate
Stock Length: 98"
Glass Thickness: 1/2" (12mm)
Suggested Gap: 3/8" (10mm)

CRL 90° Finseal For 3/8"

PC1090

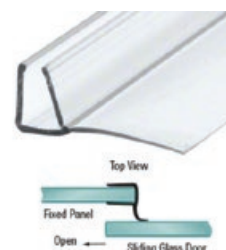

Ideal for use with sliding systems
Material: Polycarbonate
Stock Length: 95"
Glass Thickness: 3/8" (10mm)
Suggested Gap: 13/16" (20mm)

Bulb Seal For 3/8"

PR10

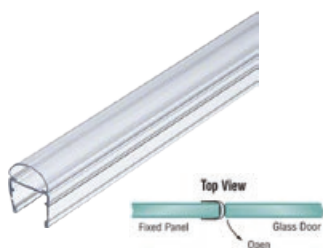

Snaps into a fixed panel or door
Material: Polycarbonate
Stock Length: 98"
Glass Thickness: 3/8" (10mm)
Suggested Gap: 1/4" (6mm)

Bulb Seal for 1/2

PR12

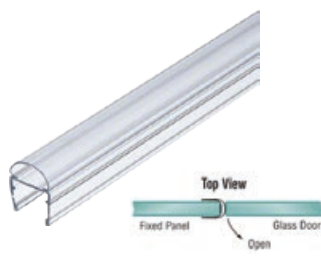

Allows doors to swing both in and out of the enclosure if desired.
Material: Polycarbonate
Stock Length: 98"
Glass Thickness: 1/2" (12mm)
Suggested Gap: 1/4" (6mm)

CRL Threshold

SDT980CLR



Pack of 5 Pcs
Type Use: Installed as a threshold in shower stalls to assist watershed back into the stall. Soft contour won't harm bare feet.
Material: Polycarbonate
Stock Length: 95"



SLIDING SHOWER DOORS

Century Sliding 180° Shower Door Kit



The Century System is a very traditional sliding system which brings an elegant fully frameless shower enclosure. The hardware is made of Aluminium and both doors slide sideways.

Item #	Max Width	Height	Towel Bar	Type	Glass Included
V-10D6460	60"	64"	24"	Tub	Yes
V-10D7260	60"	72"	24"	Shower	Yes
V-10D7660	60"	76"	24"	Shower	Yes
Y-KD8472	72"	84"	24"	Custom	No

Available Finishes



Care and Cleaning

- Use only mild detergent or warm soapy water applied with soft cloth for regular cleaning
- Always rinse well after cleaning and dry by blotting with a damp cloth
- The use of scouring pads gritty cloth and harsh abrasive cleaners should always be avoided

Glass Included

- 3/8" Tempered Glass

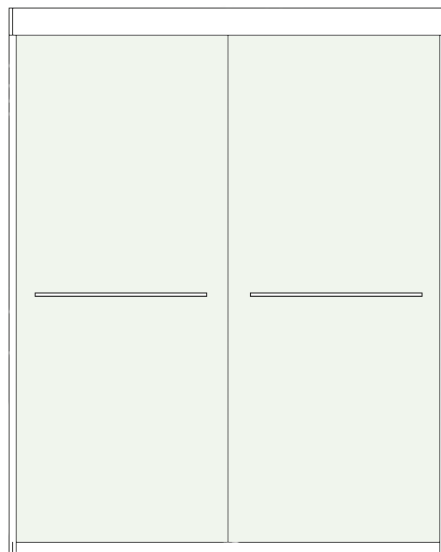

Included



(1) Bottom Sill



(1) Header



(2) Side Jambs



(4) Top Hangers with wheels



(2) Towel Bars

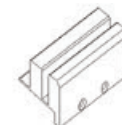

(1) Floor Guide



Denali Series Frameless Sliding Shower Door Kit (DEN180)



Our popular Denali Series Frameless Sliding Shower Door Kit offers a modern, low profile design, that includes a rectangular header and round glass rollers. It's engineered for use with 3/8" (10mm) tempered glazing. Each top glass roller requires one 5/8" (16mm) diameter hole in the glass for proper mounting. Precision bearings and wheels also offer a quiet glide experience. One standard size fits most 180 degree inline applications. Our in stock 78" wide kits can be cut to size.

NOTE: Fixed glass panel hardware like u-channels or clamps are sold separately.

Sanibel 90° Return Panel Adapter SAC90



Available Finishes



Glass Requirements

- 3/8" Tempered Glass

Specifications

- Material: Header Track and Hardware, (304 Stainless Steel)
- Glass Thickness: 5/16" to 3/8" (8 to 10mm) (Glass is not Included)
- Glass Fabrication: Each Included Glass Roller requires one 5/8" Diameter Hole; Each Included Fixed Panel Standoff Fitting requires one 1/2" Diameter Hole;
- Maximum Recommended Slider Weight: 90 lbs

Supplied With



(1) Multiway Door Guide



(2) Fixed Panel Standoff Fittings



(4) Glass Rollers



(1) Sliding Panel Stopper



(2) Wall Mount Fittings



(1) Finger Pull



(1) Jamb L-Seal



(2) WALL Mounting Screws and Anchors



(1) Header Track

Denali Series Frameless Sliding Shower Door Kit

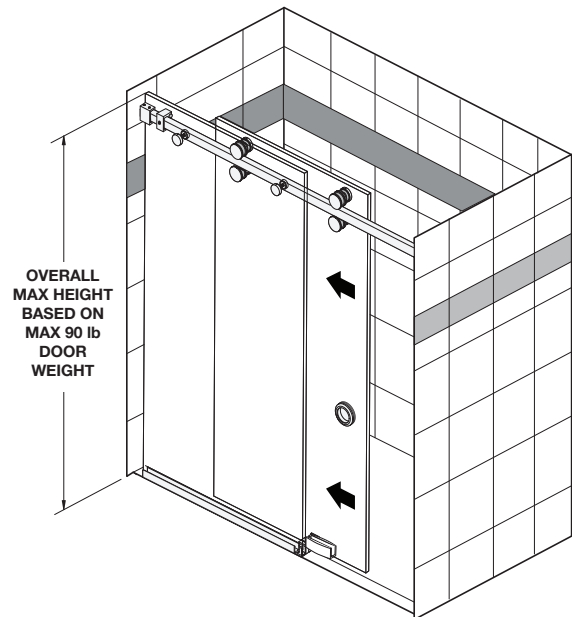
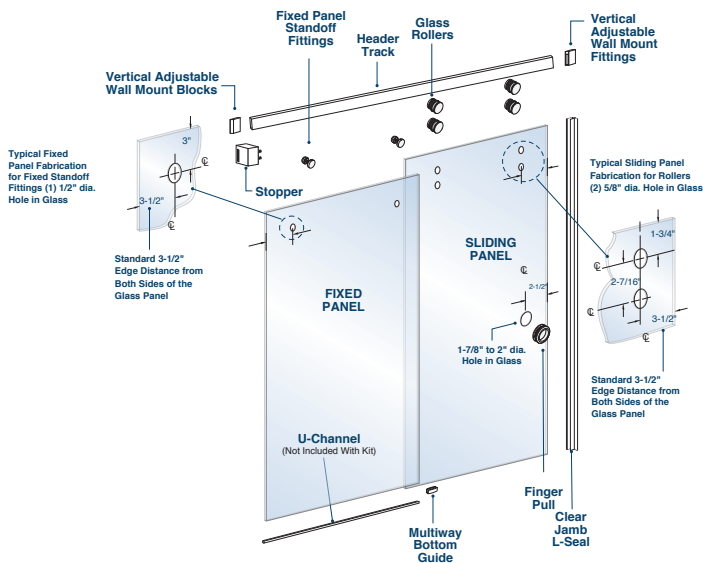
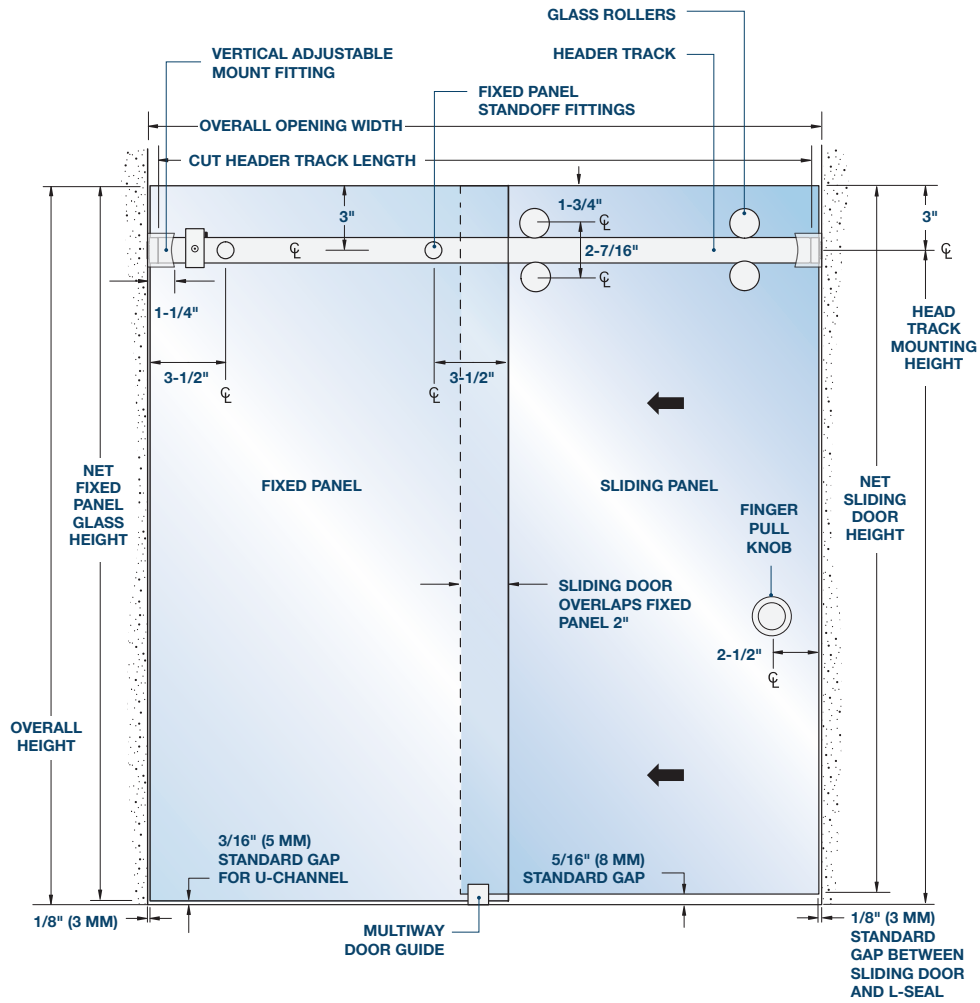

Clearwater Series Frameless Sliding Shower Door Kit (CW78)



Our popular CLEARWATER Series Frameless Sliding Shower Door Kit offers a modern, low profile design, that includes a round header bar and round glass rollers. It's engineered for use with 3/8" (10mm) or 1/2" (12mm) tempered glazing. Each top glass roller requires one 5/8" (16mm) diameter hole in the glass for proper mounting. Precision bearings and wheels also offer a quiet glide experience.

One standard size fits most 180 degree inline applications. Our stock 78" wide kits can be cut to size.

NOTE: Fixed glass panel hardware including u-channels, and clamps are sold separately. Pull sold separately.

Available Finishes



Glass Requirements

- 3/8" Tempered Glass

Specifications

- Material: Header Track and Hardware (304 Stainless Steel)
- Glass Thickness: 3/8" or 1/2" (10 or 12 mm) (Glass is not Included)
- Glass Fabrication: Each Included Glass Roller requires one 5/8" Diameter Hole; Each included Fixed Panel Standoff Fitting requires one 5/8" Diameter Hole;
- Maximum Recommended Slider Weight: 100 lbs

Supplied With



(1) Header Track



(2) Wall Mount Fitting



(4) Glass Rollers



(1) Bottom Guide



(1) Sliding Panel Stopper



(2) Fixed Panel Fitting



(1 of each) Bottom Sweep with Drip Rail



(1) Jamb L-Seal

Clearwater Series Frameless Sliding Shower Door Kit

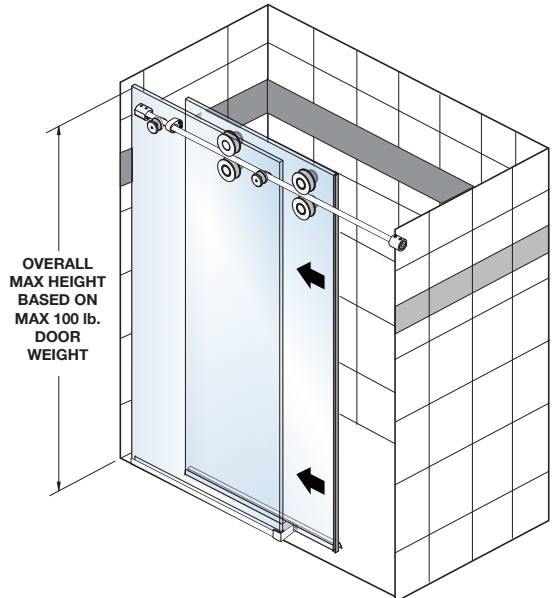
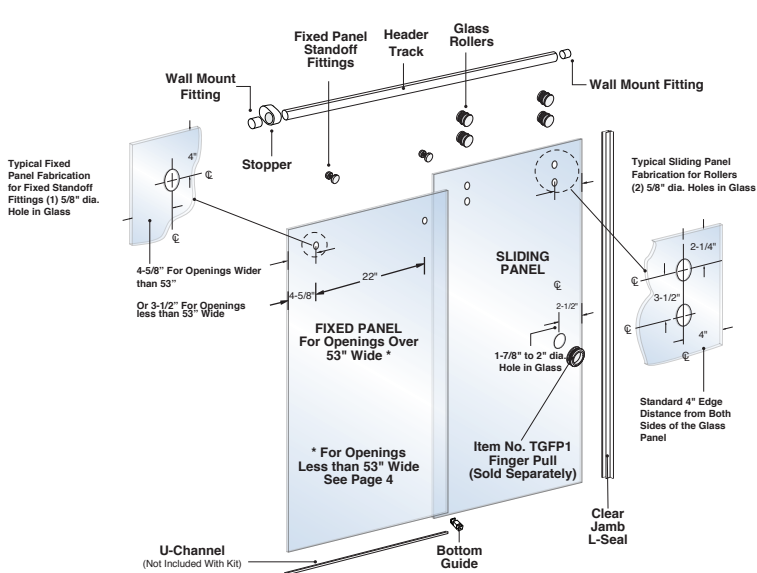
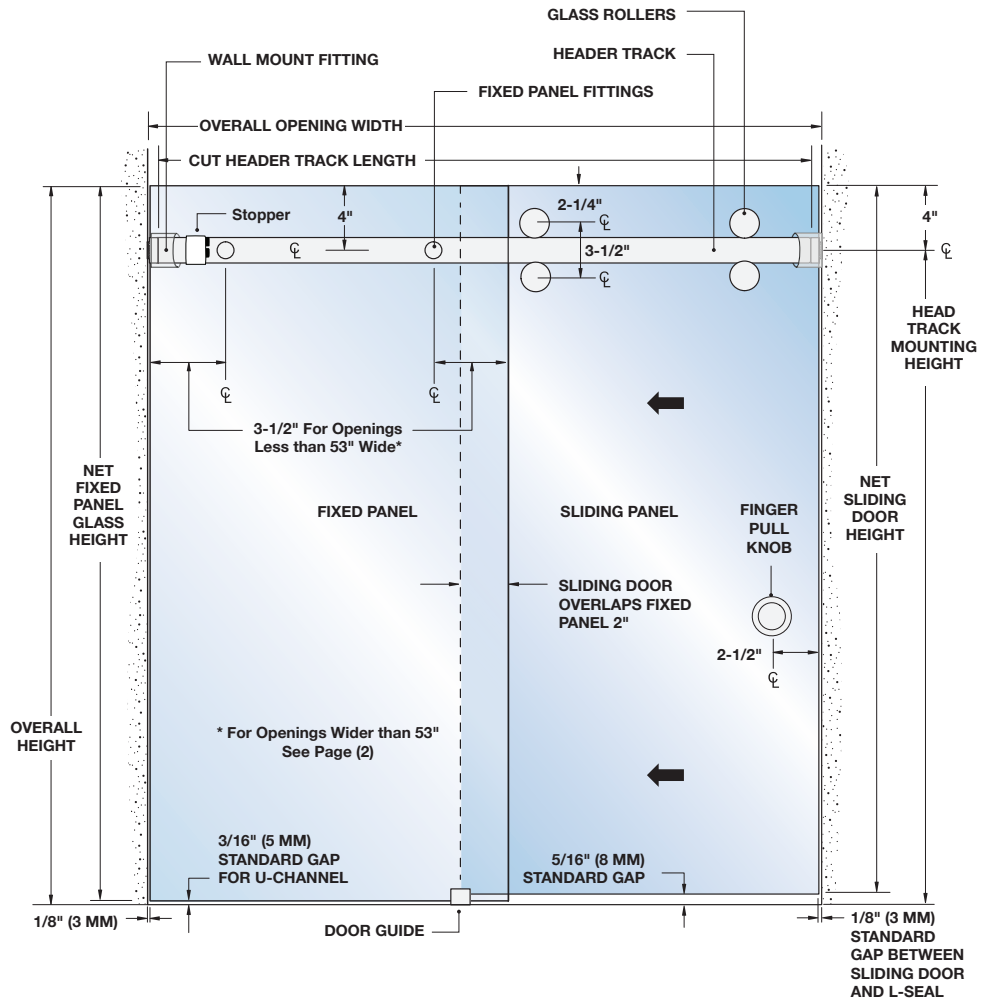

Napa Series Frameless Sliding Shower Door Kit (NAPA180)



Our Popular Napa Series Frameless Sliding Shower Door Kits offer a low-profile header track and glass rollers that are designed and manufactured from heavy-duty durable stainless-steel. Each glass roller requires one 3/4" (19mm) diameter hole for proper mounting. Precision bearings and stainless-steel wheels also offer a quiet glide opening and closing operation. Another nice feature, this system can be installed in a wide range of shower applications from full standing shower enclosures or on top of bath tubs.

One standard size fit's most 180-degree bypass inline applications. Stock Available Size: 73" Wide Kit

Available Finishes



Glass Requirements

- 3/8" Tempered Glass

Specifications

- Material: Header Track and Hardware, (Stainless Steel)
- Glass Thickness: 3/8" (10mm) (Glass is not Included)
- Glass Fabrication: Each Included Glass Roller requires one 3/4" Diameter Hole; Two 1/2" Diameter Holes are required for Each Towel Bar
- Maximum Recommended Slider Weight: 90 lbs

Supplied With



(1) Header Track



(8) Glass Rollers



(2) Wall Mount Fitting

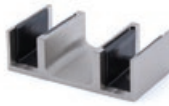

(1) Bottom Guide



(2) Sliding Panel Stopper



(2) Bottom Sweep with Drip Rail



(2) Jamb L-Seal



(1) Tool Kit/Anchors



(2) 24" (610 mm) Single Sided Towel Bars

Napa Series Frameless Sliding Shower Door Kit

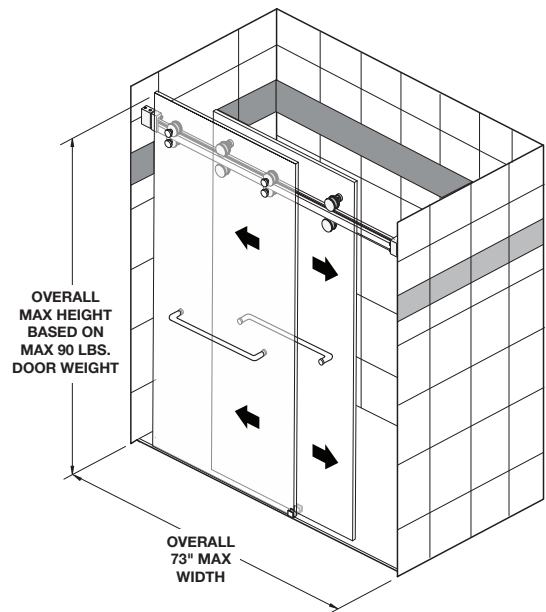
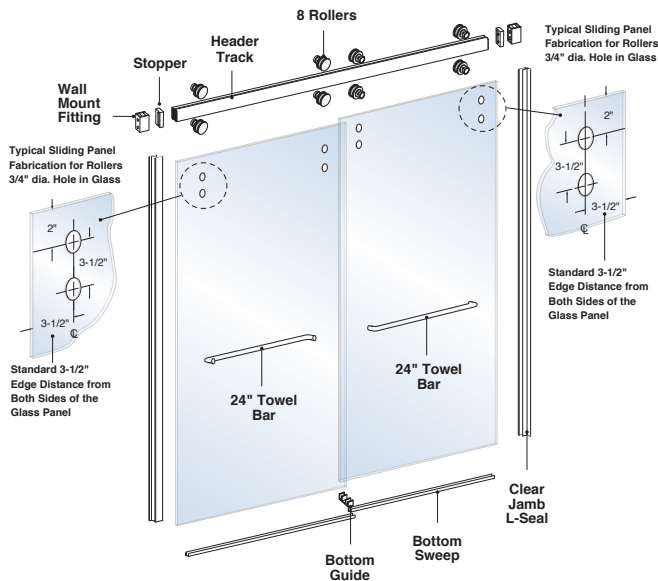
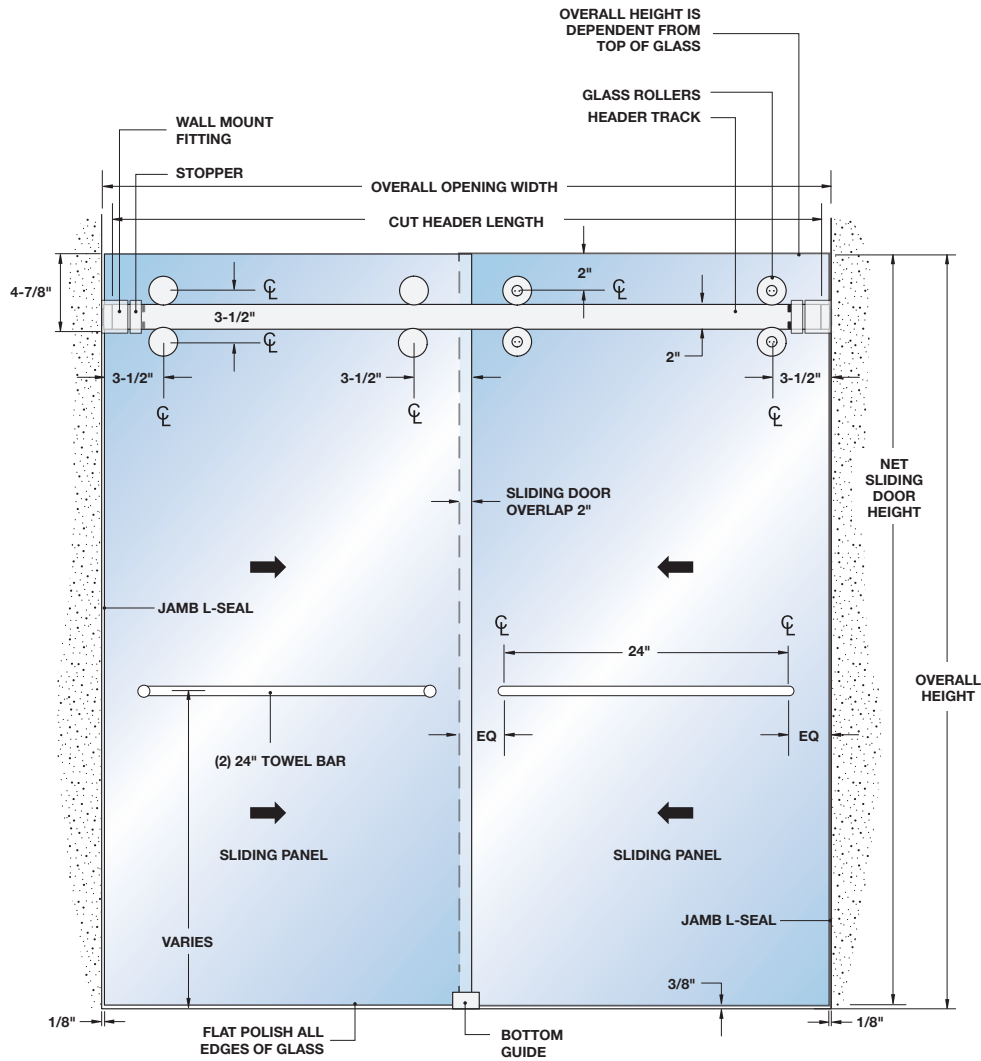



GLASS RAILINGS

Garda Base Shoe System



Thanks to the use of frameless glass, these balustrades guarantee the highest level of clean lines in new construction, renovation and restoration projects: they are available with or without caprails. The system is designed to guarantee an easy and rapid assembly and an aesthetic result ideal for the world of contemporary architecture.



Available Finishes



Glass Required

- 1/2" (12 mm) Tempered Glass
- 9/16" (13.52 mm) Laminated Tempered Glass (1/4" + 0.060" SGP) / 6.6.4
- 13/16" (21.52 mm) Laminated Tempered Glass (3/8" + 0.060" SGP) / 10.10.4

Parts Sold Individually

- See parts available in page 36



Surface Mount



Recessed Mount



Fascia Mount



BASE SHOE RAILING

Pre-Drilled Base Shoe RBS240D



Material: Aluminum
Length: 236" (6m)
48 Pre-drilled holes of 1/2" (12.5 mm)

RBS120D

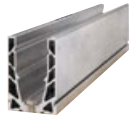

Material: Aluminum
Length: 118" (3m)
24 Pre-drilled holes of 1/2" (12.5 mm)

Pre-Drilled Lateral Shoe RLS240D

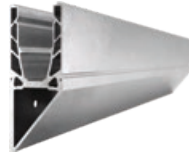

Material: Aluminum
Length: 236" (6m)
48 Pre-drilled holes of 1/2" (12.5 mm)

Adjustable Clamp



Glass Thickness	Code
1/2" (12mm)	RZ06
9/16" (6.6.4)	
13/16" (10.10.4)	RZ10

Base Shoe Top Cladding 118" (3m) RTC10



Material: Aluminum
Length: 118" (3m)

Base Shoe Cladding 118" (3m) RC10



Material: Aluminum
Length: 118" (3m)

Lateral Shoe Bottom Cladding 118" (3m) RBC10



Material: Aluminum
Length: 118" (3m)

Glazing Gasket for Cladding 100'



Glass Thickness	Code
1/2" (12 mm)	RG06X100BL
9/16" (6.6.4)	RG10X100BL
13/16" (10.10.4)	RG10X100BL

Glazing Gasket for Cladding 20'



Glass Thickness	Code
1/2" (12 mm)	RG06X20BL
9/16" (6.6.4)	RG10X20BL
13/16" (10.10.4)	RG10X20BL

Screw-Bolt+ Anchor PFM1411300



Material: Zinc
Substrate: Concrete
Size: 3/8" x 5"

Drain Block BSDB38

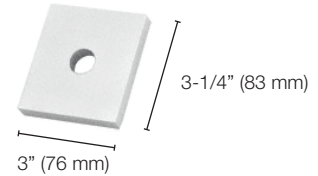

Material: Aluminum
Thickness: 3/8" (10mm)

Gasket Gap Filler Strip RGV1



Length: 12"
Fills gap between 2 pieces of glass

Mini Cap Rail RCU120



Material: Aluminum
Length: 118" (3m)
Glass Require: 13/16" (10.10.4) only
Use double face tape to mount on glass

Base Shoe End Cap REC1

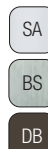

Material: Aluminum
Includes: Mounting screw

Round End Cap REC2



Material: Aluminum
Includes: Mounting screw

Glazing Gasket for Round Cap Rail 100'



Glass Thickness	Code
1/2" (12mm)	RGC6
9/16" (6.6.4)	
13/16" (10.10.4)	RGC10

Round 1.9" Cap Rail RCR120



Material: Aluminum
Length: 236" (6m)
Require: Glazing Gasket (RGC6 or RGC10)

Installation Steps

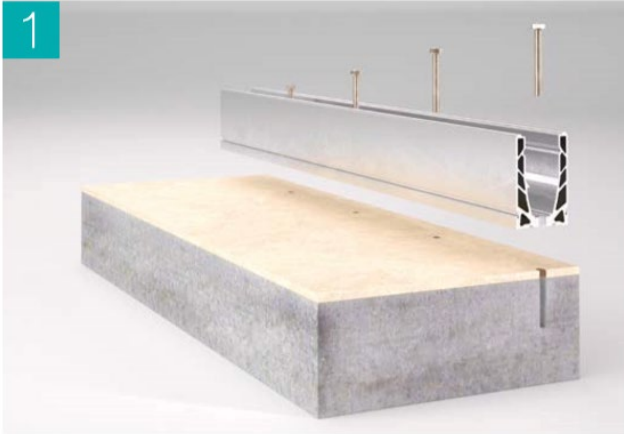

Drill the slab, position the profile and fix the screws.

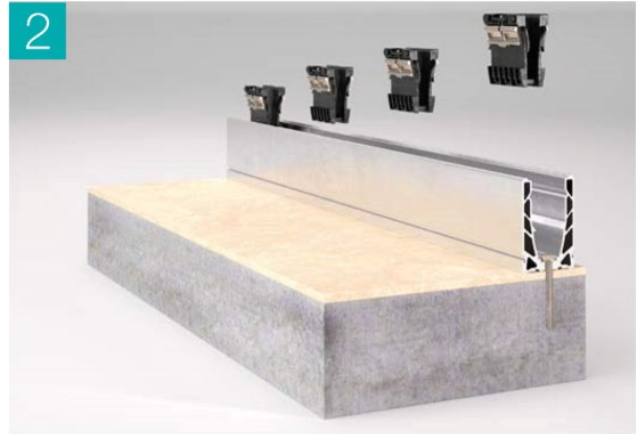

Lay the clamps inside the profile every 10". Do not place the clamps on top of the anchor screw.

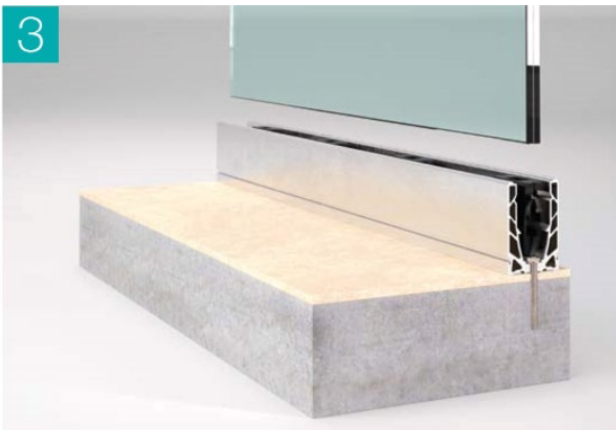

Insert the glass.



Adjust the inclination of the glass using the screws on the clamps with a 5/32" (4 mm) hex driver and tighten.



Snap the cladding in place, to which the seal has been previously inserted.

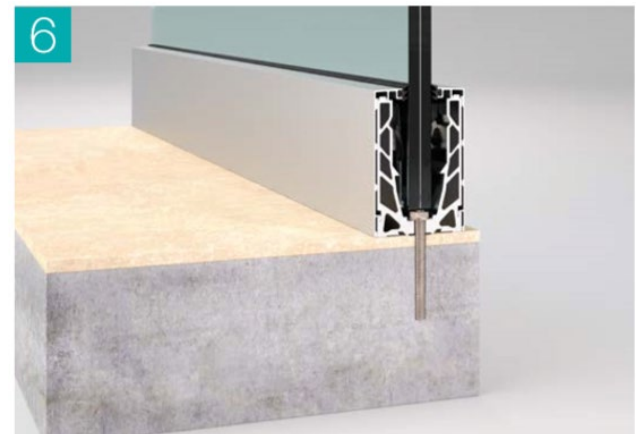

Installation Finished.

RAILING STANDOFFS

Standoff 2"

Z-RB2134

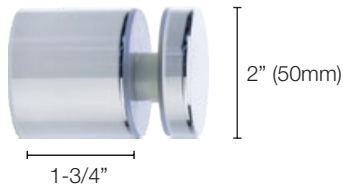

- PS
- BS
- MB

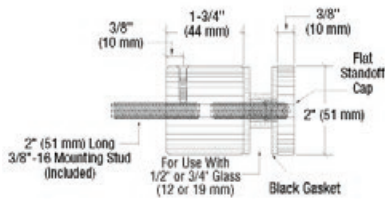

Glass Requirements

- 1/2" (12mm) Tempered Glass
- 9/16" (13.52mm) Laminated Tempered Glass
- 3/4" (19mm) Tempered Glass

Specifications

- Includes: - Socket screw for Metal Substrate
- Hanger bolt for Wood Substrate
- Material: Solid Stainless Steel 316
- Glass Fabrication: One 3/4" (19mm) Diameter Hole

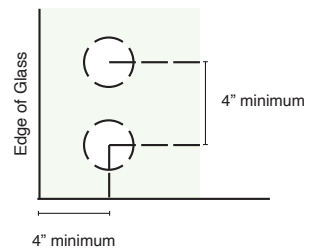

Cares

- Can be cleaned with water and a soft cloth
- Use of harsh or abrasive cleaners may harm finish and will void the warranty

Standoff 1-1/2"

E004720163

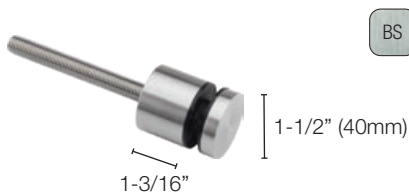

- BS

Adjustable Strap Wrench

ASW12



Tool used for tightening cap and barrel in standoffs without damaging finish. Adjustable from 3/4" to 4" diameter.

Standoff Cap Wrench 1-1/2"

E4079640

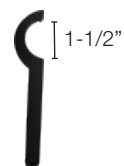

Use to tight the cap without damaging the Standoff



Handrail Tube

E0016000



Material: 316 Stainless Steel
 Diameter: 1-11/16" (42mm)
 Stock Length: 236" (6m)

Handrail Cap

E4100



Material: Stainless Steel
 Diameter: 1-11/16" (42mm)
 Designed for Hand Rail Tubing

Handrail Wall Support

E0223



Material: Stainless Steel
 Diameter: 1-11/16" (42mm)
 Designed for Hand Rail Tubing

Adjustable Handrail Glass Support

E004720172



Material: Stainless Steel
 Diameter: 1-11/16" (42mm)
 To be used in 1/2" glass to 1-1/16" (25mm) glass
 Hole Diameter Required: 3/4" (19mm)
 Designed for Hand Rail Tubing

Standoff for Wall/Countertop 1"

Z-S025BS

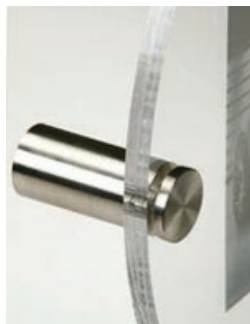

Glass Requirements

- 3/16" (5mm) Tempered Glass
- 1/4" (6mm) Tempered Glass
- 3/8" (10mm) Tempered Glass

Specifications

- Not for outdoor use
- Does not include anchor screw
- Material: Solid Stainless Steel 304
- Glass Fabrication: One 1/2" (12mm) Hole

Cares

- Can be cleaned with water and a soft cloth
- Use of harsh or abrasive cleaners may harm finish and will void the warranty



OFFICE PARTITIONS

COMMERCIAL PIVOT DOOR SYSTEM

All Glass Office/Storefront



Available Finishes



Specifications

- Material: Stainless Steel 304
- Maximum Door Height: 102" (2590mm)
- Maximum Door Width: 39" (1000mm)
- Maximum Door Weight: 220 lbs (100kg)
- Open angle: 140°
- Door hold open: 90°
- Pivot Point: 2-9/16" (65mm)

This system is an excellent option for Storefronts and Office enclosures. Requires no cutting or digging the floor, nor an overhead header. Achieve an all glass partition with the minimal hardware.

Parts Sold Individually

- See parts available in page 42 and 43

Cares

- Can be cleaned with water and a soft cloth
- Use of harsh or abrasive cleaners may harm finish and will void the warranty
- Do not use power tools when installing or spray lubricant on this hinges



COMMERCIAL PIVOT DOOR PARTS

Commercial Tubular Handle 12"

Z-CP12X12

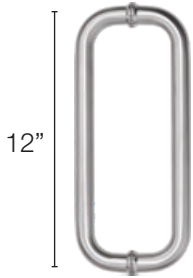

12"

Commercial Ladder Handle 24"

Z-LP24

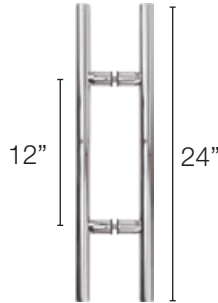

12"

24"

Commercial Ladder Handle 36"

Z-LP36

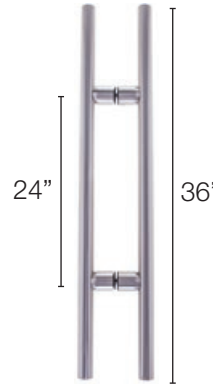

24"

36"

Locking Ladder Handle 48"

CML48

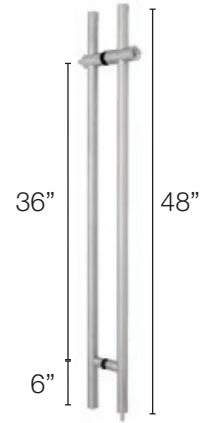

36"

48"

Includes key set and dust proof keeper
Top Hole: 1-1/4" (32mm)
Bottom Hole: 5/8" (16mm)

Material: 1-1/4" (32mm) Tubular Stainless Steel 304
Hole Diameter Required: 5/8" (15mm)

Hydraulic Patch Door Kit

PF2090



Top Patch Cut-Out

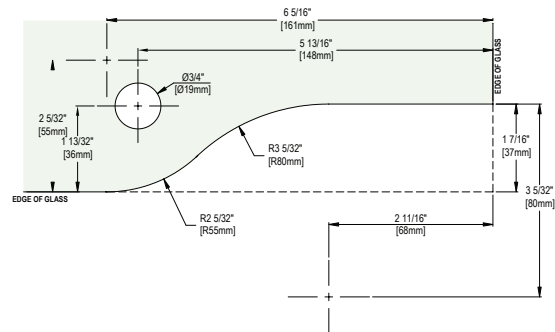

Glass Requirements

- 3/8" (10 mm) Tempered Glass
- 1/2" (12 mm) Tempered Glass

Kit Includes

- Hydraulic Bottom Patch Fitting (380H)
- Top Patch Fitting (EUR201)
- Top Centre-Hung Free Swing Pivot (1NT401)
- Top Patch Insert (1NT303)

Bottom Patch Cut-Out

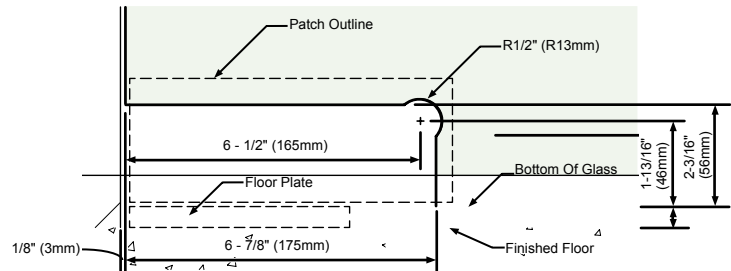

Patch Door Lock

PF205CT



Can be mounted at the bottom of the door or on the side.
Includes key set and keeper.

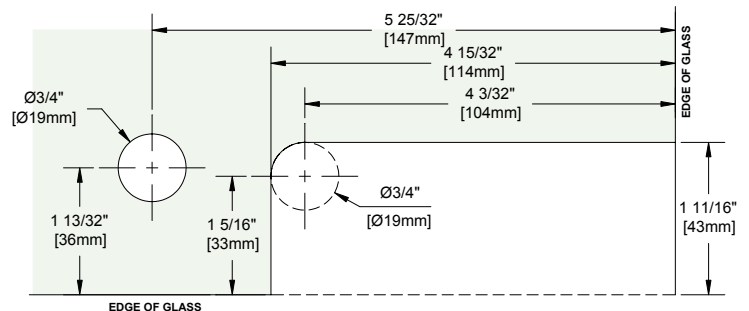

COMMERCIAL FIXED PANEL PARTS

Commercial U-Channel 1"

UC10X120

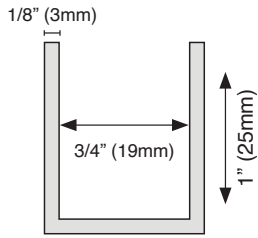

Material: Aluminum
Length: 120"

Commercial U-Channel 1-1/2"

UC15X120

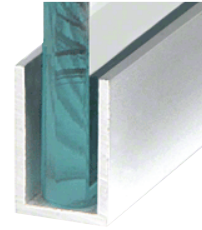
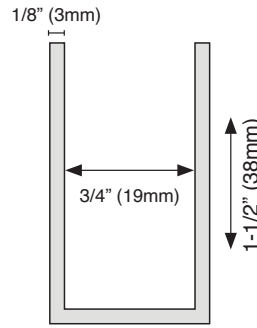

Glass Requirements

- 3/8" (10mm) Tempered Glass
- 3/8" (10.38mm) Laminated Glass
- 1/2" (12mm) Tempered Glass
- 1/2" (12.76mm) Laminated Glass
- 3/4" (19mm) Tempered Glass

End Cap For U-Channel 1"

UC10EC

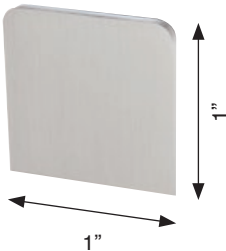

Material: Aluminum

End Cap For U-Channel 1-1/2"

UC15EC

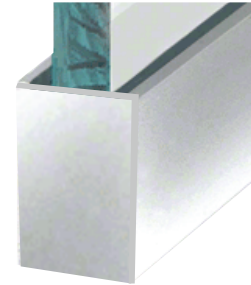
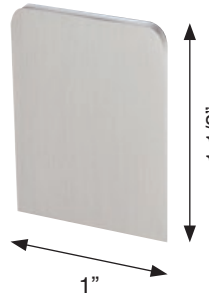

Roll-in Glazing Gasket RG38100

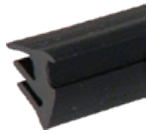

Dry glaze installation for 3/8" Glass
Length: 100'
Material: Vinyl
Color: Black

Roll-in Glazing Gasket RG12100



Dry glaze installation for 1/2" Glass
Length: 100'
Material: Vinyl
Color: Black

Gasket Roller Tool VR10



Snaps glazing gasket into u-channel

Neoprene Setting Block SB565



For use inside commercial u-channel
Dimensions: 1/2" x 1/2" x 2"
Material: Neoprene

Extra Heavy-Duty Wall Mount Bracket Z-3100

Z-3100

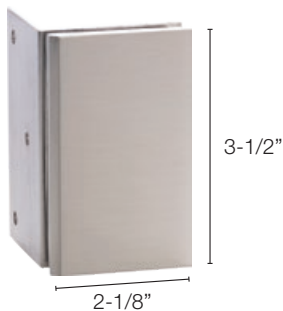

Material: Solid Brass

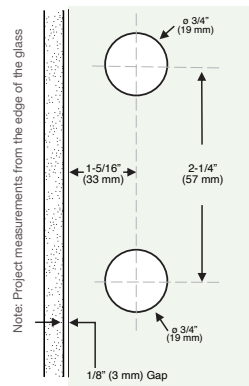

Glass Requirements

- 3/8" (10mm) Tempered Glass
- 1/2" (12mm) Tempered Glass
- 9/16" (13.52mm) Laminated Tempered

Lacrosse Barn Door Kit

LAK96

Lacrosse
Barn Style Sliding Doors



The Lacrosse Series Wall Mount Single Slider Kit contains all the components you will need (except the glass) to complete this style of installation. This model is used in applications where you are attaching a single sliding door to the inside face of a sufficiently reinforced wall. Suitable for offices, closets, storefronts or other commercial entrances.

Supplied With



(2) Track Rollers

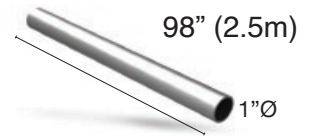

(1) Tube



(2) Track Holder Fitting



(1) Bottom Guide



(2) Stoppers



(2) End Caps

Available Finishes



Features

- Material: Stainless Steel 316
- Application: Single Glass Door
- Installation: Surface mounted
- Max Door Weight: 200 lbs (90Kg)
- Max Door Width: 48" (1200mm)

Glass Required

- 3/8" (10mm) Tempered Glass
- 1/2" (12mm) Tempered Glass
- 9/16" (13.52mm) Tempered Laminated Glass

Not Included

- Tempered Glass
- Handle

Fabrication Instructions

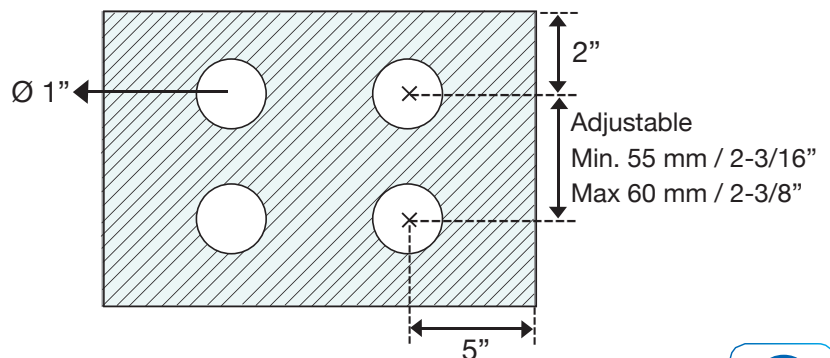

Metal Fabrication

Holes on the track should be made during installation.





WE EXPORT TO THE CARIBBEAN ISLANDS

SHIPPING OPTIONS

1. Small Shipments (LCL)

We handle transportation from our warehouse to the freight forwarder of your choice in South Florida ports.

2. Full Containers (FCL - Door to Port)

Direct shipment to most islands.

CONTAINER OPTIONS

20' Closed or Open-Top Containers

We can load multiple glass types in one shipment.

CUSTOM WOOD CRATES FOR MAXIMUM PROTECTION

- Built in-house with sturdy A-Frames.
- Forklift-friendly for easy handling.
- Ensures safe transport & consolidation with freight forwarders.



Wood Crates with A-Frame Legs Example



EAGERNESS TO LEARN

We are determined to learn and grow!

We are constantly seeking ways to expand our value for our clients. We are resourceful and resilient. We are proactive in seeking new knowledge, skills, and experiences. We accept our mistakes and learn from them. We are open and receptive to feedback and coaching to improve our work.



DREAM TEAM

Our dream team makes our clients go “wow!”

We lead by example. We communicate well. We strive to set clear expectations and alignment across the organization. We live with a strong sense of belonging. We take responsibility for outcomes, and we are empowered to make things happen. We are reliable. We can count on each other.



PEOPLE FIRST

We strive to build a family spirit!

Our greatest asset is our people. We treat each other with respect, courtesy, and professionalism. We are role models of positive attitude. We are always ready to help each other. We recognize the contributions of others. We provide our people with the tools, training, support, and empowerment that they need to achieve their personal and business goals.



THE EXTRA MILE

We find the solution and make it better!

We proactively seek opportunities to achieve extraordinary results, build lasting relationships, and exceed expectations. We stay on task until it is done. We set goals and high standards to achieve excellent results. We act as a partner to our clients, strive to understand their needs and exceed their expectations. We never give up!

 Interglass_usa

 interglasscorp

 Interglassusa

NGA
National Glass Association



INTERGLASS

USA's Largest Glass and Hardware Distributor

(800) 576-6044 | sales@interglassusa.com | www.interglassusa.com



Miami, Florida

8150 NW 64TH St.
Miami, FL 33166

Savannah, Georgia

2367 A Tremont Rd. #100
Savannah, GA 31405

Houston, Texas

10355 Deer Trail Dr.
Houston, TX 77038